

# HEALTH DEPARTMENT - 170

---

## MISSION AND SERVICES

---

**Mission** - The Health Department protects the public's health; assures availability of and access to quality health care services; and promotes individual and community responsibility for the prevention of disease, injury and disability.

**Core Services -**

- Health service resources for families and individuals in need
- Chronic disease interventions and education
- Disease prevention
- Environmental safety

**Strategic Focus in FY 2018 -**

The agency's top priorities in FY 2018 are:

- Ensure access to healthcare resources, particularly to unserved and underserved County populations
- Prevent and reduce chronic disease, with an emphasis on addressing obesity in the County
- Continue to improve maternal and infant outcomes to help decrease infant mortality
- Prevent sexually transmitted diseases
- Promote safe food services facilities
- Ensure access to mental health and substance abuse treatment

## FY 2018 BUDGET SUMMARY

---

The FY 2018 approved budget for the Health Department is \$73,158,000, a decrease of \$2,229,000 or 3.0% under the FY 2017 approved budget.

**GENERAL FUNDS**

The FY 2018 approved General Fund budget for the Health Department is \$25,572,200, an increase of \$4,978,400 or 24.2% over the FY 2017 approved budget.

**Budgetary Changes -**

<b>FY 2017 APPROVED BUDGET</b>	<b>\$20,593,800</b>
<b>Shift: Transfer of program</b> – 17 positions previously supported by the Ambulatory Funding Grant to the General Fund	\$1,013,300
<b>Increase Cost: Operating</b> – Office Automation to support agency technology needs	\$807,100
<b>Increase Cost: Fringe Benefits</b> – Increase due to compensation changes	\$790,900
<b>Increase Cost: Compensation</b> – Other compensation increase related to funding 25 out of 26 State Health Special Payment (SSP) positions	\$776,900
<b>Increase Cost: Compensation – Mandated Salary Requirements</b>	\$733,300
<b>Increase Cost: Operating</b> – Operating contract services to support costs related to the expiration of the Health Enterprise Zone (HEZ) grant program and other line items based on historical spending	\$326,100
<b>Increase Cost: Operating</b> – Operating contract services for the Health Alliance Program	\$318,200
<b>Increase Cost: Operating</b> – General and administrative contracts to align with operational needs	\$238,800
<b>Increase Cost: Compensation</b> – Other compensation increase from funding 10 to all 12 State Employee positions	\$162,400
<b>Increase Cost: Compensation</b> – Overtime for special event inspections, food truck inspection and for special projects throughout the agency	\$78,400
<b>Decrease Cost: Recovery Increase</b> - Increase in recoveries due to new position and alignment of staff within funds	(\$5,200)
<b>Decrease Cost: Operating</b> – Various operating line items decreased to align with historical spending	(\$65,400)
<b>Decrease Cost: Compensation</b> – Other compensation decrease related to attrition and vacancy lapse	(\$196,400)
<b>FY 2018 APPROVED BUDGET</b>	<b>\$25,572,200</b>

**GRANT FUNDS**

The FY 2018 approved grant budget for the Health Department is \$47,585,800, a decrease of \$7,207,400 or 13.2% under the FY 2017 approved budget. Major sources of funds in the FY 2018 approved budget include:

- Addictions Treatment Grant
- AIDS Case Management
- Women, Infants & Children (WIC)

**Budgetary Changes -**

<b>FY 2017 APPROVED BUDGET</b>	<b>\$54,793,200</b>
<b>Add: New Grants</b> – Core Services Administrative Grant, Federal Fund Treatment Grant, Offender Reentry Program (PGCORP), Overdose Education and Naloxone Distribution Program, Tobacco Administration, Tobacco Cessation, Tobacco Control Community, Tobacco Enforcement, Tobacco School Based, Wrap Around Prince George's (System of Care) Implementation, Public Health Emergency Preparedness (PHEP) Zika Supplement and Ryan White Part B	\$5,879,900
<b>Enhance: Existing Programs</b> – Continuum of Care, Drug Court Services, Prince George's County Drug Grant (Project Safety Net), Recovery Support Services, Substance Abuse Treatment Outcomes Partnership (STOP), Public Health Emergency Preparedness (PHEP), AIDS Case Management, Dental Sealant D Driver Van, High Risk Infant (Infants at Risk), Immunization Action Grant, Oral Disease and Injury Prevention, Oral Health Clinical Care, Reproductive Health, School Based Wellness - MSDE, STD Caseworker, WIC Breastfeeding Peer Counseling, Women, Infants and Children (WIC), Administrative Care Coordination Grant-Expansion and Geriatric Evaluation and Review Services	\$2,613,300
<b>Remove: Prior Year Appropriations</b> – Awards were not received in FY 2017 and the agency will not be applying in FY 2018: Ambulatory Funding, Drama Club Anger Management Program, OASIS Youth Program, Tobacco Implementation Project, Expanding Access to Dental Care, Partnership for Care Personal Responsibility Education, Cancer Diagnosis and Treatment, Partnership for Expanded Access to Health Services, Center for Medicare and Medicaid Services (CMS), Health Enterprise Zone (HEZ) and Medicare and Medicaid Services Health Care Innovations	(\$7,664,300)
<b>Reduce: Existing Programs</b> – Addictions Treatment General Grant, Administrative/LAA, Federal Block Grant, Prevention Services, Project Launch, Tobacco Enforcement Initiative, Bay Restoration (Septic) Fund, Cities Readiness Initiative (CRI), Lead Paint Poisoning Program, HIV Prevention Services, Ryan White Title I/Part A & MAI, TB Control Cooperative Agreement, TB Refugee General Medical Assistance Transportation, KIDZ Healthy Revolution Grant, Maryland Children's Health Program (MCHP) Eligibility Determination-Pregnant Women with Children (PWC) and Ryan White HIV/AIDS Treatment Modernization Act-Part A & Minority AIDS Initiative	(\$8,036,300)
<b>FY 2018 APPROVED BUDGET</b>	<b>\$47,585,800</b>

**SERVICE DELIVERY PLAN AND PERFORMANCE**

**GOAL 1** - To ensure access to healthcare resources for County residents.

**Objective 1.1** - Increase the cumulative number of County residents reached either through direct contact or outreach efforts.

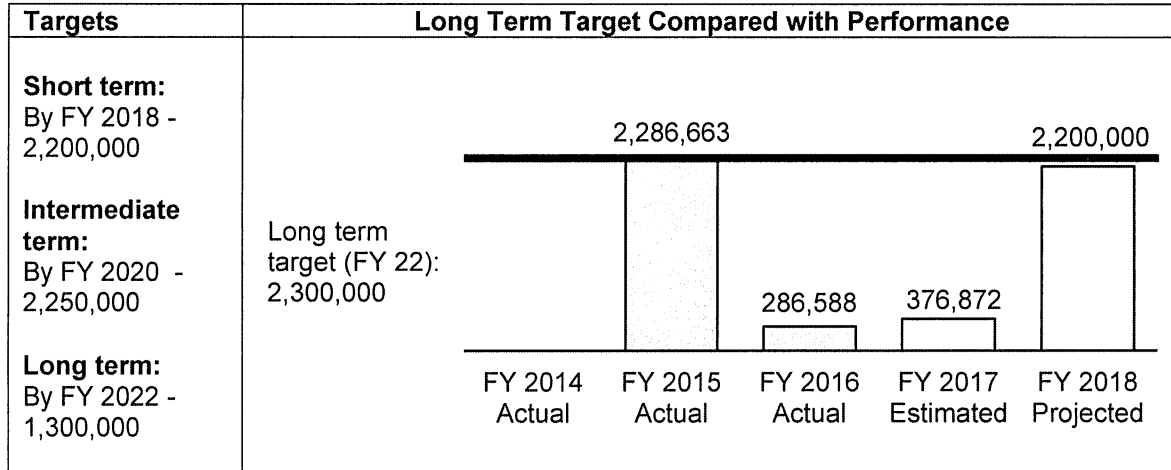

**Trend and Analysis -**

The agency is committed to ensuring access to healthcare which is the leading priority in the current health improvement plan. All agency programs are related to this goal and it is also reflected in the statewide implementation of the Affordable Care Act. Locally, one of the key ways to help increase access is to ensure a trained and knowledgeable community outreach staff is embedded across programs who connect individually with clients as well as through targeted public outreach events to increase awareness and help residents link to community resources. The overall impact of these activities is challenging to measure, since increased access to healthcare may not yield immediate results but will instead help to gradually lessen the burden of disease and disability over time. The increase projection in FY 2018 is reflective of planned community outreach projects and campaigns.

**Performance Measures -**

Measure Name	FY 2014 Actual	FY 2015 Actual	FY 2016 Actual	FY 2017 Estimated	FY 2018 Projected
<b>Resources (input)</b>					
Number of Health Department outreach workers		28	26	24	25
<b>Workload, Demand and Production (output)</b>					
Number of overall Health Department client contacts		265,165	226,117	225,852	227,000
Number of overall Health Department public outreach efforts (cumulative)		542	338	294	300
<b>Efficiency</b>					
Average number of client contacts per outreach worker		9,613	8,739	9,460	9,080
<b>Impact (outcome)</b>					
Number of County residents reached through either direct contact or outreach efforts (cumulative)		2,286,663	286,588	376,872	2,200,000

Note: Numbers might not add due to rounding.

**Strategies to Accomplish the Objective**

- **Strategy 1.1.1** - Build strategic partnerships to expand community engagement in underserved areas
- **Strategy 1.1.2** - Utilize community health workers to engage community members in appropriate healthcare
- **Strategy 1.1.3** - Recruit providers to open patient-centered medical homes in underserved areas
- **Strategy 1.1.4** - Utilize outreach events and messages to target hard-to-reach populations

**GOAL 2** - To prevent and reduce chronic disease, including obesity, among County residents.

**Objective 2.1** – Increase the number of residents participating in healthy eating active living interventions.

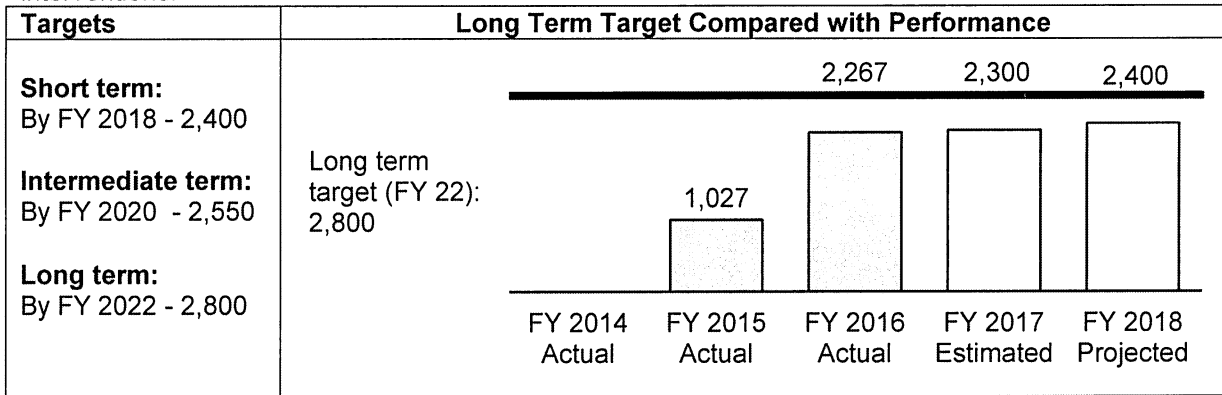

**Trend and Analysis -**

The agency is committed to targeting the common risk factors that contribute to the development of chronic diseases such as diabetes, cancer and cardiovascular disease. The agency’s strategies for the prevention and management of chronic diseases support programming to address healthy eating, active living, tobacco control and obesity interventions. There are anticipated changes to community partnerships that provide resident education for healthy eating and active living in FY 2017. The approved staffing increase in FY 2018 will ensure these services continue.

**Performance Measures -**

Measure Name	FY 2014 Actual	FY 2015 Actual	FY 2016 Actual	FY 2017 Estimated	FY 2018 Projected
<b>Resources (input)</b>					
Number of health promotion/community developer staff	9	6	2	2	5
<b>Workload, Demand and Production (output)</b>					
Number of public education campaigns addressing chronic disease across HD (average per month)		4	2	2	4
Number of cumulative residents reached by all health promotion activities		1,955,441	1,615,441	908,849	2,000,000
<b>Efficiency</b>					
<b>Impact (outcome)</b>					
Number of residents educated by healthy eating and active living interventions		1,027	2,267	2,300	2,400
Percentage change in knowledge over baseline for educational activities		11%	19%	20%	20%

**Strategies to Accomplish the Objective**

- **Strategy 2.1.1** - Build strategic partnerships to include businesses, schools and faith communities to expand community engagement
- **Strategy 2.1.2** - Implement public awareness campaign using social marketing to increase awareness of chronic diseases
- **Strategy 2.1.3** - Promote self-management and care coordination activities
- **Strategy 2.1.4** - Disseminate culturally and linguistically evidence based information and practices
- **Strategy 2.1.5** - Foster and support clinical/community linkages

**GOAL 3** - To improve reproductive health care in order to reduce infant mortality and enhance birth outcomes for women in Prince George’s County.

**Objective 3.1** - Increase the percentage of pregnant women in the County who are referred for and receive prenatal care during their first trimester.

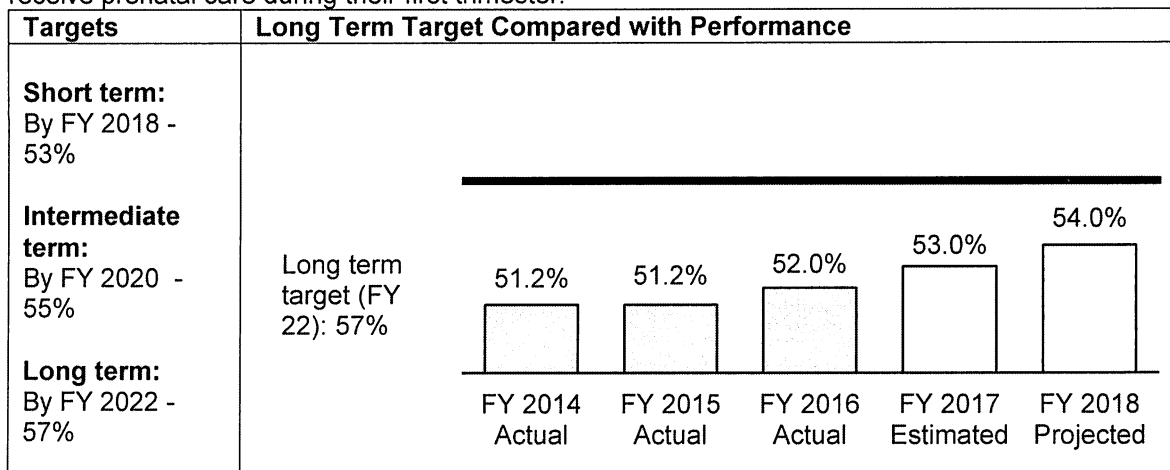

**Trend and Analysis -**

Early, appropriate and ongoing prenatal care is linked to positive pregnancy outcomes such as full-term births and babies born with birth weights within normal limits. Starting in FY 2016, maternity clinic services were no longer offered at the Health Department, but were instead provided by six community partners to make the services more accessible and available to County residents. Performance measures for Objective 3.1 show the performance of the Family Planning Clinic in the Health Department and their role in linking maternity clients to the new community partners.

**Performance Measures -**

Measure Name	FY 2014 Actual	FY 2015 Actual	FY 2016 Actual	FY 2017 Estimated	FY 2018 Projected
<b>Resources (input)</b>					
Number of scheduled family planning appointments			3,121	988	1,000
<b>Workload, Demand and Production (output)</b>					
Number of new pregnant females identified in the family planning clinic			402	460	470
Number of maternity referrals made to community partners			402	460	470
Number of family planning appointments kept			2,274	796	810
Number of women seen at family planning who are screened for domestic violence			1,003	1,196	1,200
<b>Efficiency</b>					
Proportion of kept family planning appointments compared to those scheduled.			72.9%	80.6%	81.0%
<b>Quality</b>					
Average number of days to get appointment for Family Planning Clinic			14	1	2
<b>Impact (outcome)</b>					
Percent of new mothers in the County that received first trimester care (annual measure)	51.2%	51.2%	52%	53%	54%
Percent of low birth weight babies born to County residents (annual measure)	9.2%	9.2%			
Percent of pre-term babies born to County residents (annual measure)	10.3%	10.3%			

**Strategies to Accomplish the Objective**

- **Strategy 3.1.1** - Ensure appropriate medical and social service referrals to community-based organizations and other resources for all high-risk pregnant women
- **Strategy 3.1.2** - Maintain a presence with key stakeholders and other agencies serving women and children in order to identify and refer eligible clients
- **Strategy 3.1.3** - Increase the number of met appointments in the Family Planning Clinic by improving the show rate for clients by calling clients for missed appointments and rescheduling

**Objective 3.2** - Reduce infant deaths within 12 months of birth per 1,000 live births in the County.

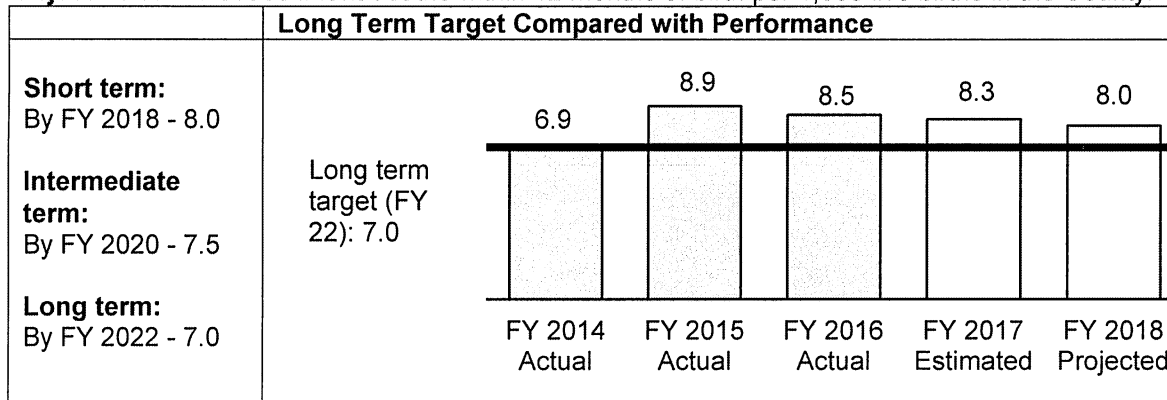

**Trend and Analysis -**

The agency has two programs working to improve birth outcomes and reduce infant mortality: Babies Born Healthy (BBH) uses perinatal coordinators to work closely with at-risk pregnant women, while the Infants at Risk program (IAR) supports mothers and their infants up to age one who are at highest risk of poor health outcomes due to medical-psychosocial issues. The agency works closely with the Prince George’s Hospital, Laurel Regional Medical Center and Medstar Southern Maryland Hospital (Other hospitals may also complete a referral or call the agency to refer a County resident). There has been an increase in referrals related to the Affordable Care Act starting in FY 2014, but the loss of a nursing position means there are fewer staff available to meet the need. A 2015 increase in infant mortality is currently being researched, and appears to be associated with older maternal age and plural births. It is important to continue the work of IAR and BBH to support women at higher risk for poor pregnancy outcomes to reduce infant deaths.



## Performance Measures -

Measure Name	FY 2014 Actual	FY 2015 Actual	FY 2016 Actual	FY 2017 Estimated	FY 2018 Projected
<b>Resources (input)</b>					
Number of IAR Staff (budgeted RNs, support staff, etc.)	3	2	2	2	2
<b>Workload, Demand and Production (output)</b>					
The number of referrals for IAR case management for children birth to age one		875	1,016	1,096	1,100
The number of home visits for new referrals for case management birth to age one		114	36	12	15
The number of home visit referrals for follow-up case management birth to age one.		82	124	116	120
The number of unduplicated mothers receiving case management services (hospital visits/phone intervention)	767	678	700	804	805
The number of teens <18 years receiving case management services	150	109	73	68	60
The number of referrals received from Prince George's Hospital	367	289	450	476	475
The number of referrals received from Laurel Regional Medical Center	35	13	3	0	3
The number of referrals received from Medstar Southern Maryland Hospital	216	91	93	116	120
<b>Quality</b>					
Number of babies/children referred to other County Resources	958	730	446	580	600
Number of mothers referred to Addictions/Mental Health		9	27	28	30
<b>Impact (outcome)</b>					
Number of infant deaths (IAR program clients can be referred to the program after an infant death)		57	30	24	25
Infant Mortality Rate (County-wide measure) per 1,000 live births (annual measure)	6.9	8.9	8.5	8.3	8.0

## Strategies to Accomplish the Objective

- **Strategy 3.2.1** - Provide prenatal information to at-risk women who live in high-risk communities by utilizing social media and targeting the faith-based and non-profit based community service groups
- **Strategy 3.2.2** - Work closely with Treatment of Mothers of Addicted Newborns (TMAN) and Children and Parents Program (CAP), the HIV Program, Healthy Families, Family Support Center, school system health educators and other resources to coordinate services for clients
- **Strategy 3.2.3** - Work closely with local hospitals to ensure high-risk infants are identified and enrolled in the IAR program

**GOAL 4** - To prevent and control sexually transmitted disease and infections in order to enhance the health of all the County's residents, workers and visitors.

**Objective 4.1** - Increase the proportion of newly diagnosed HIV positive clients with documented linkage to care.

Targets	Long Term Target Compared with Performance																		
<p><b>Short term:</b> By FY 2018 - 50%</p> <p><b>Intermediate term:</b> By FY 2020 - 55%</p> <p><b>Long term:</b> By FY 2022 - 60%</p>	<p>Long term target (FY 22): 60%</p> <table border="1"> <caption>Performance Data</caption> <thead> <tr> <th>Fiscal Year</th> <th>Performance (%)</th> <th>Status</th> </tr> </thead> <tbody> <tr> <td>FY 2014</td> <td>44%</td> <td>Actual</td> </tr> <tr> <td>FY 2015</td> <td>31%</td> <td>Actual</td> </tr> <tr> <td>FY 2016</td> <td>31%</td> <td>Actual</td> </tr> <tr> <td>FY 2017</td> <td>48%</td> <td>Estimated</td> </tr> <tr> <td>FY 2018</td> <td>50%</td> <td>Projected</td> </tr> </tbody> </table>	Fiscal Year	Performance (%)	Status	FY 2014	44%	Actual	FY 2015	31%	Actual	FY 2016	31%	Actual	FY 2017	48%	Estimated	FY 2018	50%	Projected
Fiscal Year	Performance (%)	Status																	
FY 2014	44%	Actual																	
FY 2015	31%	Actual																	
FY 2016	31%	Actual																	
FY 2017	48%	Estimated																	
FY 2018	50%	Projected																	

**Trend and Analysis -**

Prince George's County has the second highest HIV rate in Maryland after Baltimore City; as of 2014 there were 6,660 County residents living with HIV. The Health Department focuses on testing at-risk communities (Men who have Sex with Men (MSM), gay men, African American adolescents and young adults). More targeted outreach based on State and federal recommendations has resulted in fewer but more effective outreach events. Testing for HIV includes not just the actual test but pre- and post-test education to help prevent HIV infection. Linking those that test positive with consistent medical care has been shown to improve health outcomes and decrease HIV transmission. New positives as well as those previously diagnosed are assisted in connecting to care per Maryland Department of Health and Mental Hygiene (DHMH) guidelines. Staff also provide technical assistance to providers to increase the following: linkage to care and/or re-engaged to care, treatment, retention in care, educational resources, HIV service promotion, condom distribution, social networking and marketing campaigns. This measure includes individuals newly diagnosed; one challenge is some tests being anonymous so the linkage to care is not possible.

Performance Measures -

Measure Name	FY 2014 Actual	FY 2015 Actual	FY 2016 Actual	FY 2017 Estimated	FY 2018 Projected
<b>Resources (input)</b>					
Number of Preventions of Sexually Transmitted Infections staff	13	11	12	16	15
<b>Workload, Demand and Production (output)</b>					
Number of HIV-related educational outreaches and awareness opportunities	96	32	27	28	30
<b>Efficiency</b>					
Number of HIV tests performed	10,792	9,024	6,823	6,104	5,494
<b>Impact (outcome)</b>					
Number of new HIV cases per 100,000 persons (annual calculation)	47.6				
Proportion of newly diagnosed HIV positive with documented linkage to care.		44%	31%	48%	50%

Strategies to Accomplish the Objective

- **Strategy 4.1.1** - Target testing to high-risk and at-risk groups and venues
- **Strategy 4.1.2** - Increase the involvement of community-based organizations to enhance prevention, educational outreach and awareness of HIV testing and services
- **Strategy 4.1.3** - Increase condom distribution to all segments of the sexually active population, including youth, seniors and recently released offenders
- **Strategy 4.1.4** - Ensure newly diagnosed residents are linked to medical care (defined as proof of attending a post-test HIV medical appointment)

**GOAL 5** - To ensure that Prince George’s County’s physical environment is safe in order to enhance the health of all of its residents, workers and visitors.

**Objective 5.1** – Increase the percentage of required State-mandated high and moderate facility inspections conducted each year.

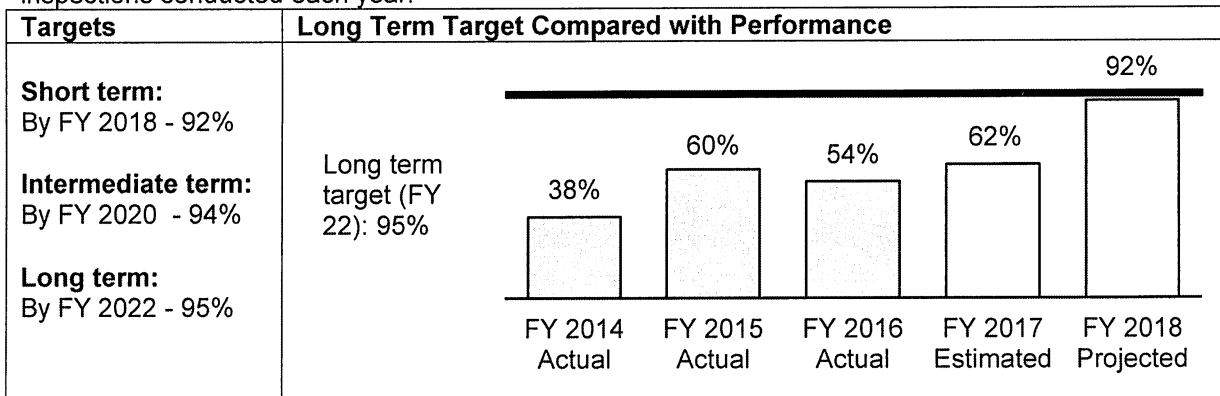

**Trend and Analysis -**

The Food Protection Program's focus is to ensure the food produced and eaten in the County is safe, through monitoring risk factors, documenting compliance, and targeting immediate and long-term issues through active managerial control. High priority food facilities require three inspections and moderate facilities require two inspections annually per COMAR. While the Food Protection Program staff has consistently performed well above industry standards, meeting the State mandate for inspections continues to be a challenge due to the lack of staff. A DHMH audit performed in 2015 suggested that the County should have 37 Environmental Health Specialists. An increase of five sanitarian staff in FY 2017 will help to better meet inspection requirements. The performance displayed accounts for time for the hiring process and onboarding staff. An additional increase in staff for FY 2018 will allow for further increase in mandatory inspections and an opportunity to focus on prevention and education for food retailers that do not meet safety standards. The program has been enrolled in the FDA's Voluntary National Retail Food Regulatory Program Standards since 2011 in order to achieve national uniformity among the nation's retail food regulatory programs.

**Performance Measures -**

Measure Name	FY 2014 Actual	FY 2015 Actual	FY 2016 Actual	FY 2017 Estimated	FY 2018 Projected
<b>Resources (input)</b>					
Number of full-time food service facility (FSF) inspectors	9	11	10	12	19
<b>Workload, Demand and Production (output)</b>					
Number of high and moderate priority FSFs that have permits	2,378	2,198	2,391	2,412	2,450
Number of high and moderate FSF inspections required by the State	6,419	5,900	6,458	6,467	6,550
Number of high and moderate priority FSFs inspected	2,423	3,535	3,514	4,020	5,200
Number of follow-up inspections of high and moderate priority FSFs	231	232	270	320	400
<b>Efficiency</b>					
Average number of high and moderate FSFs inspected per inspector	285.1	327.1	347.1	335.0	273.7
<b>Quality</b>					
Percent of "critical item" complaints responded to within 24 hours	100%	100%	100%	100%	100%
<b>Impact (outcome)</b>					
Percent of high and moderate FSFs cited for disease-related critical violations	16%	11.6%	7.6%	9.3%	8.7%
Percentage of State-mandated high and moderate inspections conducted	38%	60%	54%	62%	79%

Note: Numbers might not add due to rounding.

**Strategies to Accomplish the Objective**

- **Strategy 5.1.1** - Conduct routine food inspections for licensed food facilities, and conduct inspections based on critical violations and potential risk factors
- **Strategy 5.1.2** - Initiate an electronic inspection program to enhance the efficiency of inspections, improve continuity and reduce paperwork
- **Strategy 5.1.3** - Enhance public access to information electronically

**GOAL 6** - To ensure that County residents have access to mental health and substance abuse treatment.

**Objective 6.1** - Increase the percent of substance abuse treatment clients with a documented plan for achieving treatment goals.

Targets	Long Term Target Compared with Performance																		
<p><b>Short term:</b> By FY 2018 - 100%</p> <p><b>Intermediate term:</b> By FY 2020 - 100%</p> <p><b>Long term:</b> By FY 2022 - 100%</p>	<p>Long term target (FY 22): 100%</p> <table border="1"> <caption>Performance Data</caption> <thead> <tr> <th>Fiscal Year</th> <th>Performance (%)</th> <th>Status</th> </tr> </thead> <tbody> <tr> <td>FY 2014</td> <td>96%</td> <td>Actual</td> </tr> <tr> <td>FY 2015</td> <td>96%</td> <td>Actual</td> </tr> <tr> <td>FY 2016</td> <td>93%</td> <td>Actual</td> </tr> <tr> <td>FY 2017</td> <td>95%</td> <td>Estimated</td> </tr> <tr> <td>FY 2018</td> <td>96%</td> <td>Projected</td> </tr> </tbody> </table>	Fiscal Year	Performance (%)	Status	FY 2014	96%	Actual	FY 2015	96%	Actual	FY 2016	93%	Actual	FY 2017	95%	Estimated	FY 2018	96%	Projected
Fiscal Year	Performance (%)	Status																	
FY 2014	96%	Actual																	
FY 2015	96%	Actual																	
FY 2016	93%	Actual																	
FY 2017	95%	Estimated																	
FY 2018	96%	Projected																	

**Trend and Analysis -**

The Behavioral Health Division had two changes in electronic medical records (EMR) in FY 2016 resulting in a slight drop for this metric. But with the use of a permanent EMR and working with staff to ensure proper onboarding and training on documenting all aspects of patient care and treatment goals, FY 2017 has shown improvement. Within the agency’s own clinics, staff have continued to service a consistently high number of residents and have worked hard to ensure that those who are in need of more intensive levels of care receive the appropriate service. A realignment in FY 2018 due to a State funding reduction will reduce the staff providing substance abuse treatment services.

## Performance Measures -

Quality	FY 2014 Actual	FY 2015 Actual	FY 2016 Actual	FY 2017 Estimated	FY 2018 Projected
<b>Resources (input)</b>					
Number of professional staff providing treatment for Substance Abuse (average per month)		54	58	42	36
<b>Workload, Demand and Production (output)</b>					
Number of clients enrolled in outpatient services for Substance Abuse (average per month)		1,654	1,678	1,620	1,400
Number of cumulative clients enrolled in purchased residential services for Substance Abuse		256	173	171	175
Number of programs monitored by the Health Department to provide mental health services to County residents (average per month)		79	92	98	98
Number of clients served in community mental health services (cumulative by month)		33,213	29,144	25,092	30,897
<b>Efficiency</b>					
Number of clients who transition from a higher level to a lower level of care based on progress in treatment for Substance Abuse		134	88	90	134
<b>Impact (outcome)</b>					
Percent of clients with appropriately documented progress in achieving care, treatment, or service goals		96%	93%	95%	96%
Percent of mental health clients receiving community-based treatment who were diverted from institutional placement		60%	92%	90%	89%

## Strategies to Accomplish the Objective

- **Strategy 6.1.1** - Provide outpatient services at the appropriate intensity level to County residents
- **Strategy 6.1.2** - Carefully monitor and document client progress in achieving care, treatment or service goals
- **Strategy 6.1.3** - Ensure clients have access to residential treatment as appropriate (purchased service)
- **Strategy 6.1.4** - Ensure clients are transitioned to higher or lower levels of care based on progress in treatment

**Objective 6.2** – Increase the percent of clients receiving Crisis Response System services who divert institutionalized placement.

Targets	Long Term Target Compared with Performance																						
<b>Short term:</b> By FY 2018 - 90%	90%                      90%                      90%																						
<b>Intermediate term:</b> By FY 2020 - 91%	<table border="1" style="display: none;"> <caption>Performance Data</caption> <thead> <tr> <th>Fiscal Year</th> <th>Performance (%)</th> <th>Status</th> </tr> </thead> <tbody> <tr> <td>FY 2014</td> <td>90%</td> <td>Actual</td> </tr> <tr> <td>FY 2015</td> <td>60%</td> <td>Actual</td> </tr> <tr> <td>FY 2016</td> <td>90%</td> <td>Actual</td> </tr> <tr> <td>FY 2017</td> <td>90%</td> <td>Estimated</td> </tr> <tr> <td>FY 2018</td> <td>90%</td> <td>Projected</td> </tr> </tbody> </table>					Fiscal Year	Performance (%)	Status	FY 2014	90%	Actual	FY 2015	60%	Actual	FY 2016	90%	Actual	FY 2017	90%	Estimated	FY 2018	90%	Projected
Fiscal Year	Performance (%)	Status																					
FY 2014	90%	Actual																					
FY 2015	60%	Actual																					
FY 2016	90%	Actual																					
FY 2017	90%	Estimated																					
FY 2018	90%	Projected																					
<b>Long term:</b> By FY 2022 - 92%	Long term target (FY 22): 92%																						
	FY 2014	FY 2015	FY 2016	FY 2017	FY 2018																		
	Actual	Actual	Actual	Estimated	Projected																		

**Trend and Analysis -**

The County’s Mobile Crisis Services provider has continued to field over 1,200 calls each month and has been successful in diverting youth from institutional placements 90% of the time. Youth are reporting that the crisis intervention helped to “reduce their crisis level.” In addition, the Mobile Crisis Response Services (MCRS) vendor is performing well above the FY 2015 level, and near what was projected for FY 2017. The Health Department has worked with the vendor to restructure their staffing patterns to better the support for Child and Adolescent services including Intensive Family Intervention Team (IFIT), Hospital Diversion, and Urgent Care services, all of which support improvement in these areas.

## Performance Measures -

Measure Name	FY 2014 Actual	FY 2015 Actual	FY 2016 Actual	FY 2017 Estimated	FY 2018 Projected
<b>Resources (input)</b>					
Number of Maryland Crisis Hotline (MCH) Specialists		3	3	3	3
Number of Crisis Response System (CRS) staff		15	13	13	13
<b>Workload, Demand and Production (output)</b>					
Number of calls to the MCH		11,000	13,837	14,008	14,000
Number of calls answered by MCH		9,000	11,918	13,928	13,950
Number of calls to the CRS		5,000	4,373	2,880	3,000
Number of Mobile Crisis Team dispatches		780	1,046	1,144	1,160
<b>Efficiency</b>					
Average number of calls answered per MCH specialist		3,666	3,000	4,256	5,034
<b>Quality</b>					
Percent of MCH calls answered within 30 seconds		85%	94%	89%	90%
Average response time for CRS Mobile Crisis Team dispatches (in minutes)		60	27	30	30
<b>Impact (outcome)</b>					
Percent of youth whose crisis level has been reduced as a result of receiving Maryland Crisis Hotline services		90%	95%	95%	95%
Percent of clients receiving Crisis Response System services who divert institutionalized placement		60%	90%	90%	90%

Note: Numbers might not add due to rounding.

**Strategies to Accomplish the Objective:**

- **Strategy 6.2.1** - Ensure recipients of crisis services receive appropriate referrals to community-based services
- **Strategy 6.2.2** - Ensure that callers to the Maryland Crisis Hotline receive pre- and post- risk assessments

**FY 2017 KEY ACCOMPLISHMENTS**

- Supported MGM at National Harbor by conducting preopening inspections for 33 licensed food service facilities, a pool, two spas and a water reuse pilot program.
- Conducted Zika outreach and education activities in County neighborhoods in response to travel related cases and conducted yard investigations with the Department of Agriculture. Also prepared for public health emergencies by developing and launching four online training courses.



- Screened 100% of referrals at the refugee clinic within 45 days (better than goal of 90 days), and entered all into MD Immigration and Refugee Information System (MIRIS) for reimbursement.
- Re-established Community Action Team (CAT) to systemically address infant mortality among African American women. Developed educational projects for women and clinicians.
- Increased services at the County's four School-Based Wellness Centers to minimize health barriers to optimal academic performance by contracting with Children's National Medical Systems: comprehensive somatic, oral and mental health services are accessible to students, including undocumented and uninsured clients.
- Partnered with Prince George's County Public School System to reduce school exclusions due to immunization non-compliance by extending immunization service hours and mobile unit access.

**ORGANIZATIONAL CHART**

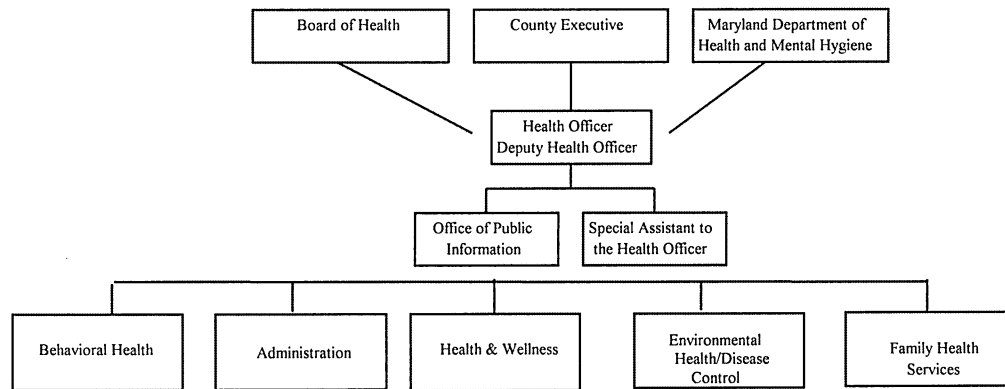

	FY2016 ACTUAL	FY2017 BUDGET	FY2017 ESTIMATED	FY2018 APPROVED	CHANGE FY17-FY18
<b>TOTAL EXPENDITURES</b>	\$ 65,282,760	\$ 75,387,000	\$ 73,919,600	\$ 73,158,000	-3%
<b>EXPENDITURE DETAIL</b>					
Administration	5,746,157	5,480,000	5,835,300	7,372,800	34.5%
Family Health Services	4,997,580	6,154,700	6,246,900	6,136,900	-0.3%
Behavioral Health	545,824	1,286,900	2,063,900	2,938,400	128.3%
Environmental Health - Disease Control	4,974,251	5,456,100	5,467,100	4,939,000	-9.5%
Health & Wellness	1,085,946	1,507,800	1,318,900	1,786,600	18.5%
Office Of The Health Officer	2,839,721	2,975,300	3,119,900	4,670,700	57%
Grants	48,478,622	54,793,200	52,134,600	47,585,800	-13.2%
Recoveries	(3,385,341)	(2,267,000)	(2,267,000)	(2,272,200)	0.2%
<b>TOTAL</b>	\$ 65,282,760	\$ 75,387,000	\$ 73,919,600	\$ 73,158,000	-3%
<b>SOURCES OF FUNDS</b>					
General Fund	\$ 16,804,138	\$ 20,593,800	\$ 21,785,000	\$ 25,572,200	24.2%
<b>Other County Operating Funds:</b>					
Grants	48,478,622	54,793,200	52,134,600	47,585,800	-13.2%
<b>TOTAL</b>	\$ 65,282,760	\$ 75,387,000	\$ 73,919,600	\$ 73,158,000	-3%

**FY2018 SOURCES OF FUNDS**

This agency is supported by two funding sources: General Fund and Grants. Major grant programs include the Addictions Treatment Grant, AIDS Case Management and Women, Infants & Children (WIC).

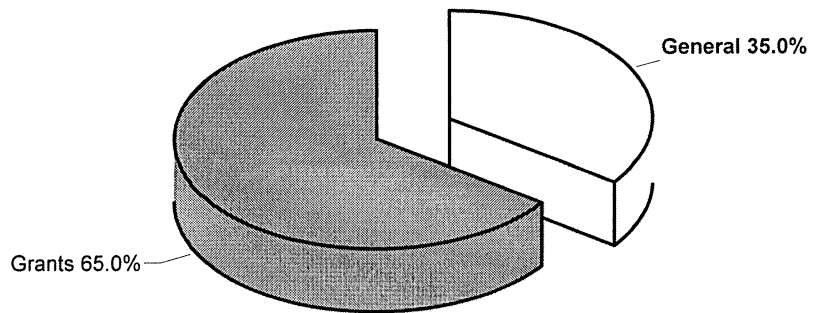

	FY2016 BUDGET	FY2017 BUDGET	FY2018 APPROVED	CHANGE FY17-FY18
<b>GENERAL FUND STAFF</b>				
Full Time - Civilian	193	198	215	17
Full Time - Sworn	0	0	0	0
Part Time	3	0	1	1
Limited Term	0	0	5	5
<b>OTHER STAFF</b>				
Full Time - Civilian	212	204	178	(26)
Full Time - Sworn	0	0	0	0
Part Time	6	5	5	0
Limited Term Grant Funded	147	141	108	-33
<b>TOTAL</b>				
Full Time - Civilian	405	402	393	(9)
Full Time - Sworn	0	0	0	0
Part Time	9	5	6	1
Limited Term	147	141	113	-28

POSITIONS BY CATEGORY	FULL TIME	PART TIME	LIMITED TERM
Program Chiefs	11	0	0
Licensed Practical Nurses	6	0	0
Disease Control Specialists	15	0	0
Environmental Sanitarians	36	0	0
Counselors	43	0	29
Social Workers	7	0	2
Nutritionists	2	0	0
Laboratory Scientists/Dental Asst./X-Ray Technicians	7	0	0
Data Processing, Information Systems	1	0	0
Accounting/Budget Staff	18	1	3
Community Developer	42	2	27
Community Development Asst/Aides	33	0	38
Permit Specialists	1	0	0
Citizen Services Specialists	4	0	0
Clinical Support (Health Aides, Psych Nurse, Driver)	5	0	4
Physician Assistants	3	0	0
Physicians/Dentist (State)	1	0	0
Security Personnel	4	0	2
Directors/Managers	11	0	0
Community Health Nurses	61	3	7
Psychologist	2	0	1
Auditor	1	0	0
Other Staff	79	0	0
<b>TOTAL</b>	<b>393</b>	<b>6</b>	<b>113</b>

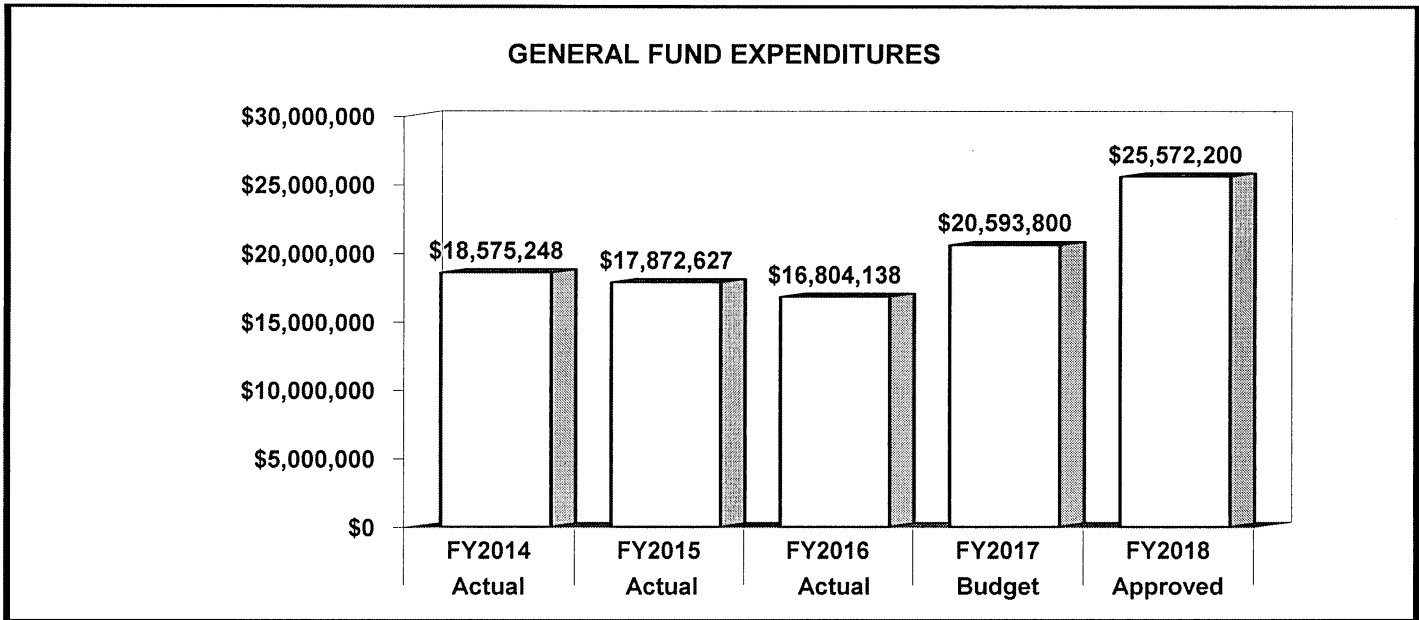

The agency's expenditures decreased 9.5% from FY 2014 to FY 2016. This decrease was primarily driven by compensation changes and operating expenses. The FY 2018 approved budget is 24.2% over the FY 2017 budget due to salary requirements and the shift of grant expenses to the General Fund.

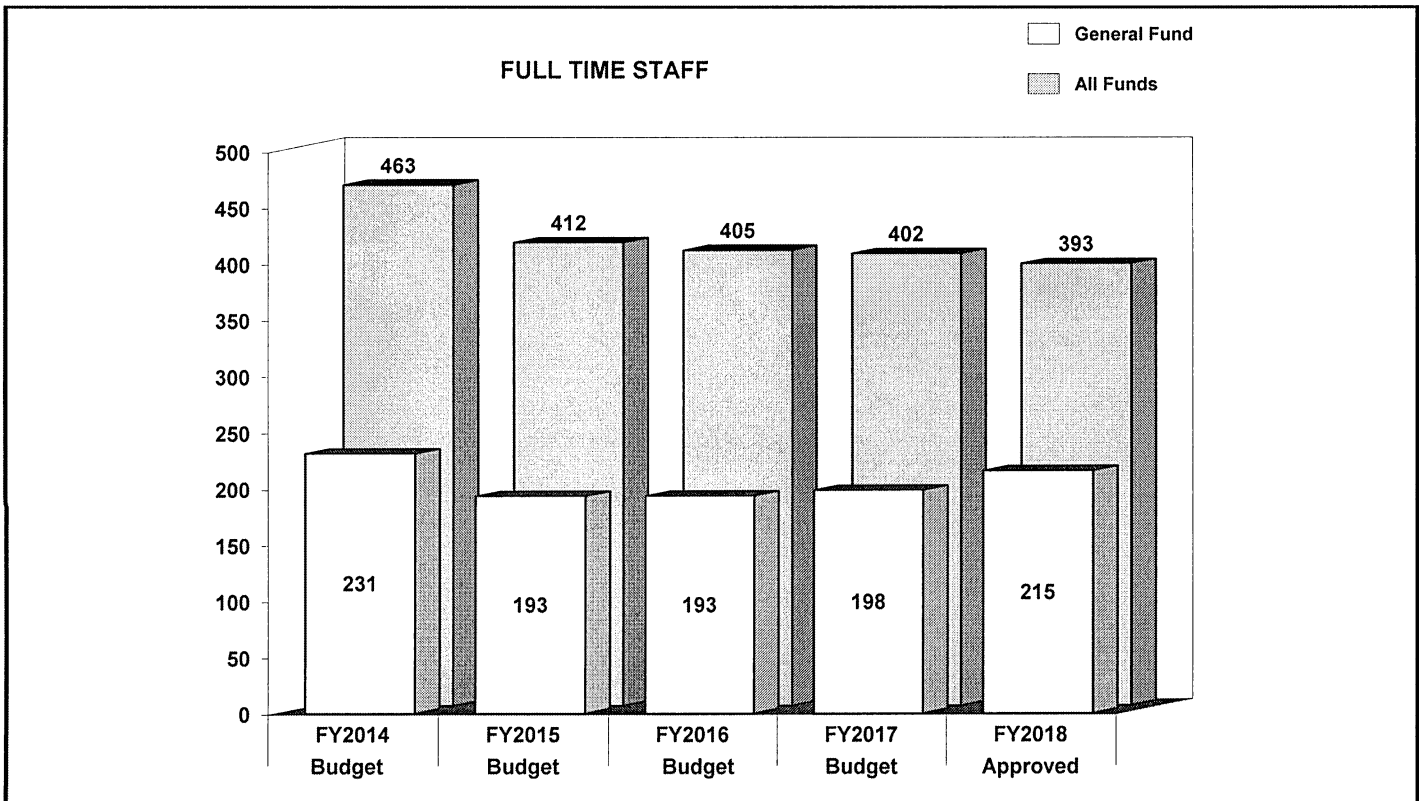

The agency's authorized staffing complement decreased by 33 positions from FY 2014 to FY 2017. This decrease is primarily the result of the abolishment of long term vacant positions. The FY 2018 staffing total increases by seventeen positions from the FY 2017 budget to reflect positions transferred from the Ambulatory Funding grant.

	FY2016 ACTUAL	FY2017 BUDGET	FY2017 ESTIMATED	FY2018 APPROVED	CHANGE FY17-FY18
<b>EXPENDITURE SUMMARY</b>					
Compensation	\$ 11,484,398	\$ 13,162,900	\$ 13,810,100	\$ 15,730,800	19.5%
Fringe Benefits	3,979,953	4,699,100	4,931,400	5,490,000	16.8%
Operating Expenses	4,725,128	4,998,800	5,310,500	6,623,600	32.5%
Capital Outlay	0	0	0	0	0%
	<b>\$ 20,189,479</b>	<b>\$ 22,860,800</b>	<b>\$ 24,052,000</b>	<b>\$ 27,844,400</b>	<b>21.8%</b>
Recoveries	(3,385,341)	(2,267,000)	(2,267,000)	(2,272,200)	0.2%
<b>TOTAL</b>	<b>\$ 16,804,138</b>	<b>\$ 20,593,800</b>	<b>\$ 21,785,000</b>	<b>\$ 25,572,200</b>	<b>24.2%</b>
<b>STAFF</b>					
Full Time - Civilian	-	198	-	215	8.6%
Full Time - Sworn	-	0	-	0	0%
Part Time	-	0	-	1	100%
Limited Term	-	0	-	5	100%

In FY 2018, compensation expenditures increase 19.5% over the FY 2017 budget due to mandated salary requirements for on-board positions and an increase in the staffing complement to support 17 positions previously funded by the Ambulatory Funding Grant program. Compensation costs includes funding for 210 out of 215 full-time positions. Fringe benefit expenditures increase 16.8% over the FY 2017 budget to align with actual costs.

Operating expenditures increase 32.5% over the FY 2017 budget due to additional resources allotted for office automation to support agency technology needs, general and administrative contracts based on historical spending and operating contract services for the Health Alliance Program.

Recoveries increase 0.2% over the FY 2017 budget due to new positions and indirect charges supported through grant programs.

MAJOR OPERATING EXPENDITURES FY2018		
Office Automation	\$	1,773,600
General and Administrative	\$	1,518,300
Contracts		
Operational Contracts	\$	1,280,400
Office and Building Rental/Lease	\$	514,500
Utilities	\$	399,400

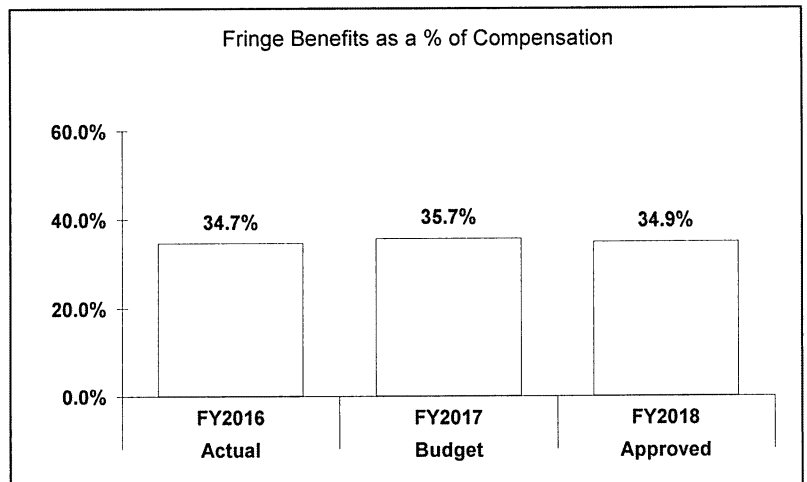

## ADMINISTRATION - 01

The Division of Administration provides the administrative support structure for the department's public health programs. This unit provides support to General Fund and grant programs through centralized fiscal (budget, accounts payable, collections and purchase card), personnel, procurement, contractual, facility maintenance, security, vital records and general services. A Health Insurance Portability and Accountability Act (HIPAA) compliance component was established in July 2010 to serve as the departmental liaison for the coordination of privacy compliance for medical records.

## Division Summary:

In FY 2018, compensation expenditures increase 13.7% over the FY 2017 budget to support the reorganization of the agency by shifting seven positions to this division from the Family Health Services Division. Compensation also includes mandated salary requirements, salary increases for State Health Special Payment (SSP) and State merit positions. Fringe benefit expenditures increase 29.5% over the FY 2017 budget to align with actual costs.

Operating expenses increase 57.6% over the FY 2017 budget due to the centralization of agency wide costs within this division, i.e. vehicle equipment/repair, technology and operational contract services. Additionally, this division will house the new Health Alliance Program. This program will support health care stakeholders throughout Prince George's County and Southern Maryland. It will provide care management solutions that help care managers, community health workers, navigators, nurses and pharmacist provide seamless coordination between case management, disease management, utilization and health and wellness functionalities.

Recoveries increase 0.3% over the FY 2017 budget budget due to indirect charges supported through grant programs.

	FY2016 ACTUAL	FY2017 BUDGET	FY2017 ESTIMATED	FY2018 APPROVED	CHANGE FY17-FY18
<b>EXPENDITURE SUMMARY</b>					
Compensation	\$ 2,150,427	\$ 2,343,700	\$ 2,380,000	\$ 2,664,300	13.7%
Fringe Benefits	932,678	836,700	849,800	1,083,600	29.5%
Operating Expenses	2,663,052	2,299,600	2,605,500	3,624,900	57.6%
Capital Outlay	0	0	0	0	0%
<b>Sub-Total</b>	<b>\$ 5,746,157</b>	<b>\$ 5,480,000</b>	<b>\$ 5,835,300</b>	<b>\$ 7,372,800</b>	<b>34.5%</b>
Recoveries	(3,385,341)	(1,932,800)	(1,932,800)	(1,938,000)	0.3%
<b>TOTAL</b>	<b>\$ 2,360,816</b>	<b>\$ 3,547,200</b>	<b>\$ 3,902,500</b>	<b>\$ 5,434,800</b>	<b>53.2%</b>
<b>STAFF</b>					
Full Time - Civilian	-	37	-	44	18.9%
Full Time - Sworn	-	0	-	0	0%
Part Time	-	0	-	0	0%
Limited Term	-	0	-	0	0%

## FAMILY HEALTH SERVICES - 02

The Family Health Services Division offers clinical and preventive health services to women, children and their families both in public health clinics and in their homes. Women's services include prenatal and postnatal care, dental care for pregnant women, family planning, pregnancy testing and health and nutritional education. Children receive immunizations, developmental assessments and referrals to medical specialty care for handicapping conditions. The division assists pregnant women and children in receiving comprehensive health care services through the Maryland Children's Health Program by providing on-site eligibility determination, managed care education and provider selection.

### Division Summary:

In FY 2018, compensation expenditures increase 7.9% over the FY 2017 budget to support the reorganization of the agency by shifting ten positions from this division to the Administration Division (seven) and the Office of the Health Officer Division (three).

Compensation also includes mandated salary requirements, salary increases for State Health Special Payment (SSP) and State merit positions. Fringe benefit expenditures decrease 10.7% under the FY 2017 budget to align with actual costs.

Operating expenses decrease 23.3% under the FY 2017 budget to reflect the shift of costs for telephones, offices supplies and vehicle equipment repair/maintenance to the Administration Division.

	FY2016 ACTUAL	FY2017 BUDGET	FY2017 ESTIMATED	FY2018 APPROVED	CHANGE FY17-FY18
<b>EXPENDITURE SUMMARY</b>					
Compensation	\$ 3,443,739	\$ 3,963,000	\$ 4,023,600	\$ 4,277,900	7.9%
Fringe Benefits	1,203,532	1,414,700	1,436,400	1,263,000	-10.7%
Operating Expenses	350,309	777,000	786,900	596,000	-23.3%
Capital Outlay	0	0	0	0	0%
<b>Sub-Total</b>	<b>\$ 4,997,580</b>	<b>\$ 6,154,700</b>	<b>\$ 6,246,900</b>	<b>\$ 6,136,900</b>	<b>-0.3%</b>
Recoveries	(384)	0	0	0	0%
<b>TOTAL</b>	<b>\$ 4,997,196</b>	<b>\$ 6,154,700</b>	<b>\$ 6,246,900</b>	<b>\$ 6,136,900</b>	<b>-0.3%</b>
<b>STAFF</b>					
Full Time - Civilian	-	62	-	52	-16.1%
Full Time - Sworn	-	0	-	0	0%
Part Time	-	0	-	0	0%
Limited Term	-	0	-	0	0%

**BEHAVIORAL HEALTH - 05**

The Behavioral Health Division provides outpatient substance abuse treatment and prevention services for adults, adolescents and their families. Tobacco education and cessation services are also provided. The Addictions Treatment Grant provides outpatient treatment services and funds contracts with private vendors for residential treatment services which provide a continuum of services. These services include intensive inpatient services, transitional community living, long-term residential rehabilitation and outpatient services for Spanish speaking residents.

## Division Summary:

In FY 2018, compensation expenditures increase 203.4% over the FY 2017 budget to support 17 positions previously supported by the Ambulatory Funding Grant. Fringe benefit expenditures increase 194.3% over the FY 2017 budget due to the shift of positions to the General Fund from grants.

Operating expenses increase 1.1% over the FY 2017 budget due to additional funding allotted for general and administrative contracts to align with historical spending.

Recoveries remain unchanged from the FY 2017 level.

	FY2016 ACTUAL	FY2017 BUDGET	FY2017 ESTIMATED	FY2018 APPROVED	CHANGE FY17-FY18
<b>EXPENDITURE SUMMARY</b>					
Compensation	\$ 192,318	\$ 603,400	\$ 1,175,200	\$ 1,830,900	203.4%
Fringe Benefits	178,302	215,500	420,700	634,200	194.3%
Operating Expenses	175,204	468,000	468,000	473,300	1.1%
Capital Outlay	0	0	0	0	0%
<b>Sub-Total</b>	<b>\$ 545,824</b>	<b>\$ 1,286,900</b>	<b>\$ 2,063,900</b>	<b>\$ 2,938,400</b>	<b>128.3%</b>
Recoveries	0	(60,000)	(60,000)	(60,000)	0%
<b>TOTAL</b>	<b>\$ 545,824</b>	<b>\$ 1,226,900</b>	<b>\$ 2,003,900</b>	<b>\$ 2,878,400</b>	<b>134.6%</b>
<b>STAFF</b>					
Full Time - Civilian	-	5	-	22	340%
Full Time - Sworn	-	0	-	0	0%
Part Time	-	0	-	0	0%
Limited Term	-	0	-	5	100%



**ENVIRONMENTAL HEALTH - DISEASE CONTROL - 06**

The Environmental Health/Disease Control Division is responsible for the licensing and/or inspection of all food service facilities, public swimming pools and spas, private water supplies and sewage disposal systems, solid waste facilities and the review of plans for all new and proposed facilities.

The Food Protection Program performs inspections of all food service facilities and provides the environmental response to all food borne outbreak investigations. The Permits and Plan Review Program evaluates and approves plans for new or remodeled food service, recreational facilities and reviews and approves all permit applications for all food service and recreational facilities.

The Environmental Engineering Program permits on-site sewage disposal systems (including Innovative and Alternative systems and shared sewage disposal facilities) and individual water supplies as well as approves new subdivisions utilizing private or shared systems.

The division also provides clinical services and disease investigations to reduce the risk of communicable diseases. Immunizations, clinical services, prevention education, animal exposure management, outbreak investigations and Communicable and Vector-Borne Disease Control. The Communicable Disease Surveillance Program maintains a database of reportable diseases; produces monthly statistics; and analyzes disease trends. Surveillance activities produce disease information and statistics for public health and medical providers.

**Division Summary:**

In FY 2018, compensation expenditures decrease 1.9% under the FY 2017 budget to support the reorganization of the agency by shifting three positions from this division to the Office of the Health Officer Division. Fringe benefit expenditures increase 11% over the FY 2017 budget to align with actual costs.

Operating expenses decrease 79.6% under the FY 2017 budget to reflect centralizing costs of office supplies and vehicle equipment repair/maintenance and general and administrative contracts to the Administration Division.

Recoveries remains unchanged from the FY 2017 level.

	FY2016 ACTUAL	FY2017 BUDGET	FY2017 ESTIMATED	FY2018 APPROVED	CHANGE FY17-FY18
<b>EXPENDITURE SUMMARY</b>					
Compensation	\$ 3,463,982	\$ 3,476,800	\$ 3,526,900	\$ 3,410,800	-1.9%
Fringe Benefits	1,067,606	1,241,200	1,259,100	1,377,400	11%
Operating Expenses	442,663	738,100	681,100	150,800	-79.6%
Capital Outlay	0	0	0	0	0%
<b>Sub-Total</b>	<b>\$ 4,974,251</b>	<b>\$ 5,456,100</b>	<b>\$ 5,467,100</b>	<b>\$ 4,939,000</b>	<b>-9.5%</b>
Recoveries	384	(187,200)	(187,200)	(187,200)	0%
<b>TOTAL</b>	<b>\$ 4,974,635</b>	<b>\$ 5,268,900</b>	<b>\$ 5,279,900</b>	<b>\$ 4,751,800</b>	<b>-9.8%</b>
<b>STAFF</b>					
Full Time - Civilian	-	57	-	54	-5.3%
Full Time - Sworn	-	0	-	0	0%
Part Time	-	0	-	0	0%
Limited Term	-	0	-	0	0%

## HEALTH &amp; WELLNESS - 08

The Health and Wellness Division is responsible for chronic disease and access to care programs. Programs identify services available to assist the elderly and chronically ill, which allow them to remain in the community in the least restrictive environment while functioning at the highest possible level of independence. For eligible clients, medical assistance grants provide in-home services and transportation.

## Division Summary:

In FY 2018, compensation expenditures increase 31.7% over the FY 2017 budget due to mandated salary requirements. The decrease in staffing is to support the reorganization of the agency by shifting one position from this division to the Office of the Health Officer Division. Fringe benefit expenditures increase 15.4% over the FY 2017 budget to align with actual costs.

Operating expenses decrease 31.1% under the FY 2017 budget to reflect centralizing costs of general and administrative contracts to Administration Division.

	FY2016 ACTUAL	FY2017 BUDGET	FY2017 ESTIMATED	FY2018 APPROVED	CHANGE FY17-FY18
<b>EXPENDITURE SUMMARY</b>					
Compensation	\$ 555,192	\$ 941,800	\$ 834,600	\$ 1,240,300	31.7%
Fringe Benefits	177,036	336,200	297,900	387,900	15.4%
Operating Expenses	353,718	229,800	186,400	158,400	-31.1%
Capital Outlay	0	0	0	0	0%
<b>Sub-Total</b>	<b>\$ 1,085,946</b>	<b>\$ 1,507,800</b>	<b>\$ 1,318,900</b>	<b>\$ 1,786,600</b>	<b>18.5%</b>
Recoveries	0	0	0	0	0%
<b>TOTAL</b>	<b>\$ 1,085,946</b>	<b>\$ 1,507,800</b>	<b>\$ 1,318,900</b>	<b>\$ 1,786,600</b>	<b>18.5%</b>
<b>STAFF</b>					
Full Time - Civilian	-	17	-	16	-5.9%
Full Time - Sworn	-	0	-	0	0%
Part Time	-	0	-	0	0%
Limited Term	-	0	-	0	0%

## OFFICE OF THE HEALTH OFFICER - 11

The Office of the Health Officer directs the departments's public health programs and activities in conformance with applicable laws, regulations, policies, procedures and standards of the State of Maryland and the County. The Office of the Health Officer assures high standards of clinical care in the department and provides public health expertise and direction. The office also coordinates and facilitates federal, State and local resources and partnerships to improve health access to care for County uninsured and under-insured residents.

Planning staff conduct community needs assessments, write health status reports and develop local health plans in accordance with federal, State and regional initiatives. Planning staff also collect, analyze and interpret health-related statistical data to identify populations at risk, establish health priorities and facilitate grant applications to improve access to health care in order to improve the status of the health of all residents and to eliminate health disparities.

The visual communications staff design, produce and distribute health information materials for public education and review existing materials for quality of content and cultural appropriateness. The Public Information Officer coordinates the agency's responses to all inquiries from the media, requests for information under the Maryland Public Information Act and legislative activities. The Ryan White CARE Act Title I staff function as the administrative agent for the entire suburban Maryland area (five counties) and are responsible for awarding grant monies, processing contracts and monitoring services provided.

### Division Summary:

In FY 2018, compensation expenditures increase 25.8% over the FY 2017 budget to support the reorganization of the agency by shifting seven positions to this division from the Family Health Services Division (three) and the Environmental Health Division (four). Compensation also includes mandated salary requirements, salary increases for State Health Special Payment (SSP) and State Merit positions. Fringe benefit expenditures increase 13.6% over the FY 2017 budget to align with actual costs.

Operating expenses increase 233.2% over the FY 2017 budget due to general and administrative contracts to align with historical spending and operating contract services to support costs related to the expiration of the Health Enterprise Zone (HEZ) grant program and other line items based on historical spending.

	FY2016 ACTUAL	FY2017 BUDGET	FY2017 ESTIMATED	FY2018 APPROVED	CHANGE FY17-FY18
<b>EXPENDITURE SUMMARY</b>					
Compensation	\$ 1,678,740	\$ 1,834,200	\$ 1,869,800	\$ 2,306,600	25.8%
Fringe Benefits	420,799	654,800	667,500	743,900	13.6%
Operating Expenses	740,182	486,300	582,600	1,620,200	233.2%
Capital Outlay	0	0	0	0	0%
<b>Sub-Total</b>	<b>\$ 2,839,721</b>	<b>\$ 2,975,300</b>	<b>\$ 3,119,900</b>	<b>\$ 4,670,700</b>	<b>57%</b>
Recoveries	0	(87,000)	(87,000)	(87,000)	0%
<b>TOTAL</b>	<b>\$ 2,839,721</b>	<b>\$ 2,888,300</b>	<b>\$ 3,032,900</b>	<b>\$ 4,583,700</b>	<b>58.7%</b>
<b>STAFF</b>					
Full Time - Civilian	-	20	-	27	35%
Full Time - Sworn	-	0	-	0	0%
Part Time	-	0	-	1	100%
Limited Term	-	0	-	0	0%

	FY 2016 ACTUAL	FY 2017 BUDGET	FY 2017 ESTIMATED	FY 2018 APPROVED	CHANGE FY17-FY18
<b>EXPENDITURE SUMMARY</b>					
Compensation	\$ 16,472,321	\$ 19,398,600	\$ 17,890,400	\$ 16,314,500	-15.9%
Fringe Benefits	4,296,256	5,426,400	5,063,400	4,888,400	-9.9%
Operating Expenses	27,873,701	30,184,600	29,285,800	26,487,900	-12.2%
Capital Outlay	-	-	-	-	0.0%
<b>TOTAL</b>	<b>\$ 48,642,278</b>	<b>\$ 55,009,600</b>	<b>\$ 52,239,600</b>	<b>\$ 47,690,800</b>	<b>-13.3%</b>

The FY 2018 approved budget is \$47,690,800, a decrease of 13.3% from the FY 2017 budget. This decrease is largely driven by the expiration of the Ambulatory Funding Grant. The program has become a fee-for-service program and has been transferred to the General Fund. Additionally, the department does not intend to pursue funding for Cancer Diagnosis and Treatment and Center for Medicare and Medicaid Services (CMS) programs. Reduced funding is anticipated for Addictions Treatment Grant, AIDS Case Management, General Medical Assistance Transportation and Ryan White HIV/AIDS Treatment Modernization Act-Part A & Minority AIDS Initiative programs and lastly the expiration of the Health Enterprise Zone (HEZ) program.

STAFF SUMMARY BY DIVISION & GRANT PROGRAM	FY 2017			FY 2018		
	FT	PT	LTGF	FT	PT	LTGF
<b><u>Behavioral Health Services</u></b>						
Addictions Treatment Grant	44	1	22	16	1	7
Administrative Grant	6	0	2	2	0	1
Ambulatory Funding	0	0	0	2	0	0
Bridges 2 Success (OSK)	0	0	5	1	0	4
Children in the Need of Assistance- Senate Bill 512	0	0	1	0	0	1
Core Services Administrative Grant	0	0	0	6	0	2
Crownsville Project	0	0	1	0	0	1
Drug and Alcohol Prevention	2	0	1	2	0	0
Drug Court Services	1	0	0	1	0	0
Federal Treatment Grant	2	0	3	2	0	1
Integration of Child Welfare Funds- House Bill 7	1	0	0	1	0	0
Integration of Sexual Health in Recovery	1	0	0	1	0	0
Mental Health Services Grant	0	0	1	1	0	1
Oasis Youth Program	2	0	0	0	0	0
Offender ReEntry Grant	0	0	4	0	0	6
Project Launch	0	0	2	0	0	2
Project Safety Net	5	0	9	6	0	9
Recovery Support Services Grant	2	0	8	2	0	10
Temporary Cash Assistance	3	0	2	3	0	2
Smart ReEntry				0	0	5
Substance Abuse Treatment Outcome Partnership (STOP)	6	0	3	6	0	2
Tobacco Enforcement Initiative	0	0	3	0	0	1
Tobacco Implementation Grant	1	0	0	0	0	1
<b>Sub-Total</b>	<b>76</b>	<b>1</b>	<b>67</b>	<b>52</b>	<b>1</b>	<b>56</b>
<b><u>Environmental Health and Disease Control</u></b>						
Cities Readiness Initiatives (CRI)	1	0	0	1	0	0
Hepatitis B Prevention	1	0	0	1	0	0
Public Health Emergency Preparedness	3	0	0	3	0	0
<b>Sub-Total</b>	<b>5</b>	<b>0</b>	<b>0</b>	<b>5</b>	<b>0</b>	<b>0</b>
<b><u>Family Health</u></b>						
AIDS Case Management	12	0	5	0	0	0
Babies Born Healthy	1	0	1	1	0	1
Dental Sealant	1	0	3	0	0	2
Healthy Teens and Young Adult	6	0	0	5	0	0
High Risk Infant (Infants At Risk)	1	0	0	1	0	0
HIV Prevention Services	5	1	4	5	1	3
Immunization Action Grant	1	0	0	1	0	0
Partnership for Care	0	0	2	0	0	0
Reproductive Health	5	1	0	5	1	0
Ryan White Part A	13	0	6	15	0	5
Ryan White Part B	0	0	0	14	0	3
STD Caseworker	5	0	2	6	0	6
Surveillance and Quality Improvement	1	0	0	1	0	1
TB Control	3	0	1	2	0	0
TB Refugee	3	0	1	4	0	1
Women, Infants & Children (WIC)	18	0	10	18	0	9
WIC Breast Feeding Peer Counseling	0	0	4	0	0	4
<b>Sub-Total</b>	<b>75</b>	<b>2</b>	<b>39</b>	<b>78</b>	<b>2</b>	<b>35</b>

STAFF SUMMARY BY DIVISION & GRANT PROGRAM	FY 2017			FY 2018		
	FT	PT	LTGF	FT	PT	LTGF
<b>Health and Wellness</b>						
Administrative Care Coordination (HealthLine)	12	0	2	12	0	1
Geriatric Evaluation and Review Services (STEPS/AERS)	6	0	1	5	0	0
MCHP Eligibility Determination - PWC	18	1	11	14	2	6
Medical Assistance Transportation	9	0	12	9	0	7
<b>Sub-Total</b>	<b>45</b>	<b>1</b>	<b>26</b>	<b>40</b>	<b>2</b>	<b>14</b>
<b>Office of the Health Officer</b>						
Health Enterprise Zone	0	1	6	0	0	0
Ryan White	3	0	3	3	0	3
<b>Sub-Total</b>	<b>3</b>	<b>1</b>	<b>9</b>	<b>3</b>	<b>0</b>	<b>3</b>
<b>TOTAL</b>	<b>204</b>	<b>5</b>	<b>141</b>	<b>178</b>	<b>5</b>	<b>108</b>

In FY 2018, funding is provided for 178 full-time, 5 part-time and 108 limited term grant funded (LTGF) positions.

#### Behavioral Health Division

Full-time and LTGF staffing levels are decreasing overall by 35 positions primarily related to the reduction in the Addictions Treatment Grant program.

#### Environmental Health and Disease Control Division

Staffing total remains unchanged from the FY 2017 level.

#### Family Health Division

Full-time and LTGF staffing levels are decreasing overall by one position.

#### Health and Wellness Division

Full-time and LTGF staffing levels are decreasing overall by 16 positions primarily related to the MCHP Eligibility Determination - PWC program.

#### Office of the Health Officer

Full-time and LTGF staffing levels are decreasing overall by 7 positions primarily related to the expiration of the Health Enterprise Zone program.

**HEALTH DEPARTMENT - 170**

**GRANTS**

GRANTS BY DIVISION	FY 2016 ACTUAL	FY 2017 APPROVED	FY 2017 ESTIMATED	FY 2018 APPROVED	\$ CHANGE FY17 - FY18	% CHANGE FY17 - FY18
<b><u>Division of Behavioral Health Services</u></b>						
Addictions Treatment Grant	\$ 9,087,582	\$ 5,215,300	\$ 3,729,600	\$ 3,023,200	\$ (2,192,100)	-42.0%
Administrative/LAA	785,421	790,100	327,000	327,000	(463,100)	-58.6%
Ambulatory Funding	-	2,149,100	2,149,000	-	(2,149,100)	-100.0%
Bridges 2 Success fka Operation Safe Kids	206,723	350,000	350,000	350,000	-	0.0%
Continuum of Care	562,929	569,200	627,600	627,600	58,400	10.3%
Core Services Administrative Grant	5,234	-	790,100	790,100	790,100	100.0%
Crownsville Project	55,011	74,300	74,300	74,300	-	0.0%
Drama Club Anger Management Program	-	30,000	-	-	(30,000)	-100.0%
Drug and Alcohol Prevention	467,230	-	-	-	-	0.0%
Drug Court Services	-	130,600	130,500	131,600	1,000	0.8%
Federal Block Grant	1,327,126	1,338,300	1,338,300	1,138,300	(200,000)	-14.9%
Federal Fund Treatment Grant	1,013,564	-	1,158,600	1,158,600	1,158,600	100.0%
HIDTA	-	136,000	136,000	136,000	-	0.0%
House Bill 7 - Integration of Child Welfare Funds	-	71,000	71,000	71,000	-	0.0%
Integration of Sexual Health in Recovery	202,332	216,500	216,500	216,500	-	0.0%
Mental Health Services Grant	1,630,757	1,758,400	1,758,400	1,758,400	-	0.0%
OASIS Youth Program	136,023	101,800	-	-	(101,800)	-100.0%
Offender Reentry Prog. (PGCORP)	11,067	-	399,800	399,800	399,800	100.0%
Overdose Education and Naloxone Distribution Program	32,351	-	15,600	15,600	15,600	0.0%
Path Program	106,652	106,700	106,700	106,700	-	0.0%
Prevention Services	-	505,800	505,700	502,700	(3,100)	-0.6%
Project Launch	651,673	672,500	664,100	664,100	(8,400)	-1.2%
Prince George's County Drug Grant (Project Safety Net)	1,392,504	1,214,600	1,214,600	1,214,700	100	0.0%
Recovery Support Services	11,357	847,500	847,500	914,400	66,900	7.9%
Safe Neighborhoods	575,547	-	-	-	-	0.0%
Senate Bill 512 Children In Need of Assistance	-	60,000	60,000	60,000	-	0.0%
Smart Reentry - OJP	-	-	997,300	-	-	0.0%
Substance Abuse Treatment Outcomes Partnership (STOP)	(163,497)	643,700	643,700	644,600	900	0.1%
Tobacco Administration	20,542	-	20,500	20,500	20,500	100.0%
Temporary Cash Assistance	-	455,900	455,900	455,900	-	0.0%
Tobacco Cessation	164,555	-	172,900	152,400	152,400	100.0%
Tobacco Control Community	71,115	-	82,400	102,800	102,800	100.0%
Tobacco Enforcement	-	-	13,000	13,000	13,000	100.0%
Tobacco School Based	27,481	-	13,300	13,300	13,300	100.0%
Tobacco Enforcement Initiative	205,082	213,100	120,000	125,000	(88,100)	-41.3%
Tobacco Implementation Project	1,829	293,400	-	-	(293,400)	-100.0%
Wrap Around Prince George's (System of Care) Implementation	-	-	998,800	998,800	998,800	100.0%
<b>Sub-Total</b>	<b>\$ 18,588,191</b>	<b>\$ 17,943,800</b>	<b>\$ 20,188,700</b>	<b>\$ 16,206,900</b>	<b>\$ (1,736,900)</b>	<b>-9.7%</b>
<b><u>Division of Environmental Health and Disease Control</u></b>						
Bay Restoration (Septic) Fund	\$ 103,012	\$ 300,000	\$ 110,000	265,000	\$ (35,000)	-11.7%
Cities Readiness Initiative (CRI)	155,709	155,600	137,600	144,900	(10,700)	-6.9%
Hepatitis B Prevention	68,779	68,500	68,500	68,500	-	0.0%
Lead Paint Poisoning Program	48,271	57,300	53,200	53,200	(4,100)	-7.2%
Public Health Emergency Preparedness (PHEP)	478,316	517,100	455,000	593,100	76,000	14.7%
PHEP Ebola	36,240	-	-	-	-	0.0%
PHEP Ebola Supplement (Zika #1)	-	-	15,000	-	-	0.0%
PHEP Zika Supplement	-	-	15,000	15,000	15,000	100.0%
<b>Sub-Total</b>	<b>\$ 890,327</b>	<b>\$ 1,098,500</b>	<b>\$ 854,300</b>	<b>\$ 1,139,700</b>	<b>\$ 41,200</b>	<b>3.8%</b>

# HEALTH DEPARTMENT - 170

# GRANTS

GRANTS BY DIVISION	FY 2016 ACTUAL	FY 2017 APPROVED	FY 2017 ESTIMATED	FY 2018 APPROVED	\$ CHANGE FY17 - FY18	% CHANGE FY17 - FY18
<b><u>Division of Family Health</u></b>						
Abstinence Education	\$ 20	\$ -	\$ -	\$ -	\$ -	0.0%
AIDS Case Management	1,936,272	2,245,500	500,000	3,000,000	754,500	33.6%
Babies Born Healthy	122,653	129,500	128,000	129,500	-	0.0%
Crenshaw Perinatal	(340)	-	-	-	-	0.0%
Dental Sealant D Driver Van	176,950	210,000	200,000	215,000	5,000	2.4%
Expanding Access to Dental Care	-	200,000	-	-	(200,000)	-100.0%
Healthy Teens/Young Adults	536,834	559,500	555,000	559,500	-	0.0%
High Risk Infant (Infants at Risk)	114,683	117,600	116,000	117,700	100	0.1%
HIV Prevention Services	705,129	1,660,800	925,000	1,000,000	(660,800)	-39.8%
Immunization Action Grant	207,515	284,900	275,000	290,000	5,100	1.8%
Infant and Toddlers	381,626	-	-	-	-	0.0%
Linkage to Care	(27)	-	-	-	-	0.0%
Maryland Strategic Prevention Framework	3,880	-	-	-	-	0.0%
Oral Disease and Injury Prevention	39,556	40,000	40,000	150,000	110,000	275.0%
Oral Health Clinical Care	42,150	42,000	42,000	43,000	1,000	2.4%
Partnership for Care	135,967	150,000	-	-	(150,000)	-100.0%
Personal Responsibility Education	36,606	85,000	-	-	(85,000)	-100.0%
Project Leadership Initiatives For Tomorrow	40,836	-	-	-	-	0.0%
Recovery Housing for Women	692,421	-	-	-	-	0.0%
Reproductive Health	440,481	514,400	500,000	518,000	3,600	0.7%
Ryan White Title I/Part A & MAI	2,076,717	2,410,800	2,200,000	2,000,000	(410,800)	-17.0%
Ryan White Part B	(248)	-	2,492,500	2,200,000	2,200,000	100.0%
School Based Wellness Center	310,582	850,000	850,000	850,000	-	0.0%
School Based Wellness - MSDE	8,698	405,900	405,900	406,000	100	0.1%
STD Caseworker	541,511	975,800	950,000	980,000	4,200	0.4%
Surveillance and Quality Improvement	127,053	142,600	140,000	142,600	-	0.0%
TB Control Cooperative Agreement (transferred from Environmental Health)	220,192	377,600	345,000	350,000	(27,600)	-7.3%
TB Refugee (transferred from Environmental Health)	456,193	763,200	715,000	700,000	(63,200)	-8.3%
WIC Breastfeeding Peer Counseling	172,304	245,100	240,000	246,000	900	0.4%
Women, Infants and Children (WIC)	2,185,172	2,422,700	2,400,000	2,430,000	7,300	0.3%
<b>Sub-Total</b>	<b>\$ 11,711,385</b>	<b>\$ 14,832,900</b>	<b>\$ 14,019,400</b>	<b>\$ 16,327,300</b>	<b>\$ 1,494,400</b>	<b>10.1%</b>
<b><u>Division of Health and Wellness</u></b>						
Administrative Care Coordination Grant-Expansion (transferred from Family Health)	\$ 1,130,600	\$ 126,000	\$ 1,098,700	\$ 1,456,300	\$ 1,330,300	1055.8%
CDC Breast and Cervical Cancer Program	106,231	-	-	-	-	0.0%
Cancer Prevention, Education, and Screening	699,640	-	-	-	-	0.0%
Cancer Diagnosis and Treatment	141,439	1,155,000	-	-	(1,155,000)	-100.0%
Cancer Outreach	10,270	-	-	-	-	0.0%
Electronic Health Records Meaningful Use	97,945	-	-	-	-	0.0%
General Medical Assistance Transportation	-	5,247,600	4,017,400	4,184,800	(1,062,800)	-20.3%
Geriatric Evaluation and Review Services (Revenue)	-	701,800	768,800	879,300	177,500	25.3%
Geriatric Evaluation and Review Services (Grant)	721,987	-	-	10,400	10,400	100.0%
KIDZ Healthy Revolution Grant	-	240,000	95,700	100,000	(140,000)	-58.3%
Komen National Vulnerable Population Grant	26,459	-	-	-	-	0.0%
MCHP Eligibility Determination-PWC (transferred from Environmental Health)	1,820,227	2,017,900	1,795,100	1,962,800	(55,100)	-2.7%
Partnership for Expanded Access to Health Services	-	500,000	-	-	(500,000)	-100.0%
Tobacco Dependence	60,979	-	-	-	-	0.0%
<b>Sub-Total</b>	<b>\$ 4,815,777</b>	<b>\$ 9,988,300</b>	<b>\$ 7,775,700</b>	<b>\$ 8,593,600</b>	<b>\$ (1,394,700)</b>	<b>-14.0%</b>



# HEALTH DEPARTMENT - 170

# GRANTS

GRANTS BY DIVISION	FY 2016 ACTUAL	FY 2017 APPROVED	FY 2017 ESTIMATED	FY 2018 APPROVED	\$ CHANGE FY17 - FY18	% CHANGE FY17 - FY18
<b><u>Office of the Health Officer</u></b>						
Affordable Care Act	\$ -	\$ -	\$ 105,500	\$ -	\$ -	0.0%
Center for Medicare and Medicaid Services (CMS)	-	1,000,000	1,067,400	-	(1,000,000)	-100.0%
Health Enterprise Zone (HEZ)	1,186,138	1,100,000	-	-	(1,100,000)	-100.0%
Medical Assistance Transportation	3,712,956	-	-	-	-	0.0%
Medicare and Medicaid Services Health Care Innovations	205,536	900,000	-	-	(900,000)	-100.0%
Ryan White HIV/AIDS Treatment Modernization Act- Part A & Minority AIDS Initiative	6,963,408	7,929,700	8,123,600	5,318,300	(2,611,400)	-32.9%
System of Care	404,903	-	-	-	-	0.0%
<b>Sub-Total</b>	<b>\$ 12,472,942</b>	<b>\$ 10,929,700</b>	<b>\$ 9,296,500</b>	<b>\$ 5,318,300</b>	<b>\$ (5,611,400)</b>	<b>-51.3%</b>
<b>HD Total Grants - Outside Sources</b>	<b>\$ 48,478,622</b>	<b>\$ 54,793,200</b>	<b>\$ 52,134,600</b>	<b>\$ 47,585,800</b>	<b>\$ (7,207,400)</b>	<b>-13.2%</b>
<b>Total Transfer from General Fund - (County Contribution/Cash Match)</b>	<b>\$ 163,656</b>	<b>\$ 216,400</b>	<b>\$ 105,000</b>	<b>\$ 105,000</b>	<b>\$ (111,400)</b>	<b>-51.5%</b>
<b>Total Grant Expenditures</b>	<b>\$ 48,642,278</b>	<b>\$ 55,009,600</b>	<b>\$ 52,239,600</b>	<b>\$ 47,690,800</b>	<b>\$ (7,318,800)</b>	<b>-13.3%</b>

**DIVISION OF BEHAVIORAL HEALTH SERVICES -- \$16,206,900**

Grants within this division support services for adults, adolescents and families with behavioral health needs, including addictions and mental health, as well as prevention services for high-risk youth and families. The Behavioral Health program supports outpatient and intensive outpatient treatment services delivered by Health Department staff, as well as outpatient and residential treatment services delivered through contracts with private providers. The division also receives funding for interventions to target special populations in our community, including but not limited to tobacco prevention, offender re-entry, and special services for pregnant and post-partum women. The High Intensity Drug Trafficking Areas (HIDTA) program enhances and coordinates drug control efforts among local, State and federal law enforcement agencies. The Division is also responsible for long-range planning for behavioral health services in the county, needs assessments and the development of alternative resource providers.

**DIVISION OF ENVIRONMENTAL HEALTH AND DISEASE CONTROL -- \$1,139,700**

The Public Health Emergency Preparedness Grant supports planning activities and the integrated efforts between County health civic organizations and health care facilities to train medical practitioners and citizen volunteers in emergency preparedness; establishing dispensing sites and shelters; and implementing emergency response strategies in the event of a man-made or natural disaster. The Bay Restoration Fund provides funds for on-site sewage disposal system upgrades using the best available technology for nitrogen removal. The Cities Readiness Initiative is specific to incident management.

**DIVISION OF FAMILY HEALTH -- \$16,327,300**

Grant funded programs serve at-risk, predominantly uninsured/underinsured populations including infants and children, adolescents, pregnant women and women of childbearing age through early diagnosis, screening, treatment, counseling, education, follow-up, case management, referral, linkage to Medicaid, and nutrition services (including WIC). Funding also supports necessary services to individuals with specific types of communicable diseases such as Sexually Transmitted Diseases and HIV/AIDS and extensive community education activities. The Personal Responsibility Education Programs provide pregnancy prevention education before marriage. The Dental Sealant Grant provides dental care to the County public schools via mobile van. The Immunization Program focuses on providing immunization services to ensure that children attain full compliance with recommended immunization schedules and can enter school on time. The School Based Wellness Center Program provides collaboration with the Prince George's County Board of Education to provide extended operating hours and services to the community. The Tuberculosis (TB) Refugee grant provides for TB screening and various evaluations for refugees.

**DIVISION OF HEALTH AND WELLNESS -- \$8,593,600**

Grant funding supports prevention and/or mitigation of heart disease and diabetes through the use of community screens, referral services and interventions to assist individuals with lifestyle decisions/changes. Medical Assistance grants provide personal care and case management to frail elderly individuals with chronic diseases or developmentally disabled persons and transportation to medical appointments for Medical Assistance recipients. Grant funding is also used to evaluate the needs of individuals at risk of institutionalization, and to purchase services to prevent their placement in a nursing home or other health care facility.

**OFFICE OF THE HEALTH OFFICER -- \$5,318,300**

The Ryan White CARE Act Title I staff function as the administrative agent for the entire suburban Maryland area (five counties) and are responsible for the awarding of grant monies, processing contracts, and monitoring services provided. Grant funding is used for comprehensive care services to HIV patients eligible for services under the Ryan White grant of \$3.5 million.