

Prince George's County



Design Manual for Small Wireless Facilities



JANUARY 31, 2020

DEPARTMENT OF PUBLIC WORKS AND TRANSPORTATION
OFFICE OF INFORMATION TECHNOLOGY



Contents

SECTION 1	GOALS AND GUIDELINES	1
SECTION 2	GENERAL DEFINITIONS	2
SECTION 3	POLE-MOUNTED SMALL WIRELESS FACILITY	10
SECTION 4	APPLICATION TYPES	14
4.1	<i>Co-location Application for a Pre-existing Structure</i>	14
4.2	<i>Replacement Pole Application</i>	14
4.3	<i>New Pole Application</i>	16
SECTION 5	SMALL WIRELESS FACILITY LOCATIONS	19
SECTION 6	TECHNICAL AND AESTHETIC REQUIREMENTS	21
6.1	<i>Prohibited Structures</i>	21
6.2	<i>Right-of-Way</i>	21
6.3	<i>Electric Supply and Backhaul Connections</i>	22
6.4	<i>Ground Equipment</i>	23
6.5	<i>Pole-Mounted Equipment</i>	23
6.6	<i>Placement of Facilities</i>	23
6.7	<i>Wooden Utility Poles</i>	25
SECTION 7	UNDERGROUNDING	26
SECTION 8	RADIO FREQUENCY EXPOSURE	27
8.1	<i>Radio Frequency Signage Requirements</i>	27
8.2	<i>Emergency Radio Frequency / Power Shut-Off</i>	28
8.3	<i>Licensed Frequencies</i>	28
SECTION 9	BACKUP POWER	29
SECTION 10	LIGHTING AND NOISE	29
SECTION 11	APPLICATION SUBMITTALS	30
11.1	<i>Radio Frequency Analysis</i>	30
11.2	<i>Structural Analysis</i>	32
11.3	<i>Construction Drawings</i>	33
SECTION 12	TERMS AND PROVISIONS	50
APPENDIX A	STANDARD / PRE-APPROVED DESIGNS	50



Figures

Figure 1	CONCEPTUAL LAYOUT WOOD UTILITY POLE WITH POLE-MOUNTED EQUIPMENT .	11
Figure 2	CONCEPTUAL LAYOUT STEEL POLE WITH POLE-MOUNTED EQUIPMENT	12
Figure 3	CONCEPTUAL LAYOUT STEEL POLE WITH CONCEALED EQUIPMENT AT POLE BASE	13
Figure 4	RADIO FREQUENCY SIGNAGE	27
Figure 5	REQUIRED SUBMITTALS BY APPLICATION TYPE	31
Figure 6	SAMPLE PLAN VIEW SUITABLE LINE WEIGHTS AND ANNOTATIONS	35
Figure 7	SAMPLE POLE PROFILE VIEW SUITABLE LINE WEIGHTS AND ANNOTATIONS.....	36
Figure 8	SAMPLE BASE MAP (USE FOR 5-SQUARE-MILE AREA MAP).....	39
Figure 9	SAMPLE "TOTAL CUBIC FEET" NOTE	44
Figure 10	COUNTY DPW&T TYPICAL DETAIL (SAMPLE)	46
Figure 11	LIGHTING PHOTOMETRICS OUTPUT (SAMPLE).....	47
Figure 12	COMMUNICATIONS DEMARCATION POINT (AERIAL EQUIPMENT).....	48
Figure 13	COMMUNICATIONS DEMARCATION POINT (UNDERGROUND EQUIPMENT)	49
Figure 14	DESIGN 1 – SMOOTH, CYLINDRICAL STREETLIGHT POLE.....	51
Figure 15	DESIGN 2 – STREETLIGHT POLE WITH EQUIPMENT IN POLE BASE.....	52
Figure 16	DESIGN 3 – STREETLIGHT POLE WITH EQUIPMENT IN POLE-MOUNTED CABINET..	53
Figure 17	DESIGN 4 – DECORATIVE STREETLIGHT POLE	54
Figure 18	CONDUIT TYPICAL	55

Acknowledgements





SECTION 1 GOALS AND GUIDELINES

Prince George's County has established technical and aesthetic standards (Standards) to govern access to and use of the Public Rights-of-Way and County structures and lands by wireless carriers, infrastructure companies, or others (collectively referred to as "Applicants") for installation of "Small Wireless Facilities" (SWF) and associated equipment (as defined by the U.S. Federal Communications Commission (FCC)).

This Design Manual is intended to ensure the safety of the public and of County employees, and protect the community's aesthetic standards. It is a part of an evolving process that considers the ongoing development of communications technologies and may be amended to accommodate future technological and regulatory changes.

All Applicants must follow the National Electrical Safety Code (NESC) and all other applicable engineering standards, FCC standards, and other federal, state, and local laws, standards and codes that are effective as of the Application filing date. Development of the Design Manual uses Subtitles 5A and 23 of the Prince George's County Code; the *Policy and Specification for Utility Installation and Maintenance*, including Appendix E.1, *Policy and Standards for Small Wireless Facility Installation and Maintenance*; and the *Department of Public Works and Transportation Specifications and Standards for Roadways and Bridges (2012)* as a foundation, as well as the County's unique operational and aesthetic requirements.



SECTION 2 GENERAL DEFINITIONS

1. **Antenna** means an apparatus designed for the purpose of emitting radio frequency (RF) radiation, to be operated or operating from a fixed location pursuant to FCC authorization for the provision of wireless service and any commingled information services. Such apparatus includes but are not limited to, directional Antennas, such as panels, microwave dishes, satellite dishes, and omni directional Antennas, such as whips.
2. **Antenna Equipment** means equipment, switches, wiring, cabling, power sources, shelters, shrouds, enclosures, or cabinets associated with an Antenna, located at the same fixed location as the Antenna, and, when co-located, is mounted or installed at the same time as such Antenna.
3. **Antenna Facility** means an Antenna and associated Antenna Equipment.
4. **Applicant** means a Person who submits an Application. The term includes the Persons who will be the owners of the Facility or on whose behalf the work will be performed, as well as the Person who may submit an Application, which shall in any case be signed by the entity which will own the Facility or on whose behalf the work is performed.
5. **Application** means a request submitted electronically by an Applicant for the Telecommunications Transmission Facility Coordinating Committee (TTFCC) to review and evaluate a proposed new or modified Telecommunications Transmission Facility within Prince George's County, Maryland. A TTFCC Application includes all the requirements for submission of a TTFCC Application and any subsequent information to amend the Application or in reply to requests for additional information.
6. **Base Station** means a structure or equipment at a fixed location used for the provision of personal wireless services and that enables Federal Communications Commission-licensed or authorized wireless communications between user equipment and a communications network. The term includes, but is not limited to, radio transceivers, Antennas, coaxial or fiber-optic cable at the site, regular and backup power supplies, and comparable equipment, regardless of technological configuration. The term does not include a Tower or other Support Structure, as



defined herein, and it does not include Facilities (other than wireless devices at the Base Station) that connect a Base Station at a fixed location to other elements of a communications network at other locations. The term does not include metering equipment or disconnects required to provide power to the Base Station.

7. **Capacity** means the maximum number of users a cell site can support, taking into consideration the network overhead information, the services offered, and the wireless service provider's spectrum availability.
8. **Co-location** means:
 - a. the mounting or installation of an Antenna Facility on a pre-existing structure for the purpose of transmitting and/or receiving radio frequency signals for communication purposes, whether or not there is an existing Facility on the Tower, building, or structure; or
 - b. the modification of a pre-existing structure for the purpose of mounting or installing an Antenna on that structure.
9. **Concealment** means any Small Wireless Facility or Pole that is covered, blended, painted, disguised, camouflaged or otherwise concealed such that the Small Wireless Facility blends into the surrounding environment and is visually unobtrusive.
10. **Construct** means to install, erect, build, affix or otherwise place any fixed structure or object.
11. **Coverage Maps** (see **Radio Frequency Propagation Contour Maps**)
12. **Design Manual** means the *Design Manual for Small Wireless Facilities* promulgated by the County. The Design Manual contains design standards including, but not limited to, the appearance, height, and size of Small Wireless Facilities.
13. **Director** means the Director of the Department of Permitting, Inspections and Enforcement.
14. **Emergency** means a condition that:
 - a. poses a clear and immediate danger to life or health, or of a significant loss of property; or
 - b. requires immediate repair or replacement to restore service to a user.



15. **Facility** or **Facilities** means equipment and installations of any kind, including but not limited to any lines, pipes, irrigation systems, wires, cables, conduit Facilities, ducts, Poles, Towers, vaults, pedestals, boxes, appliances, Antennas, transmitters, gates, meters, appurtenances, or other equipment. A reference to a Facility refers both to the Facility considered as a whole and the individual elements of a Facility.
16. **FCC** means the Federal Communications Commission, its designee, or any successor governmental entity thereto.
17. **Install** means the placing of a Facility, whether initially or as part of the repair, modification, replacement, removal or expansion of an existing Facility, and includes any process by which a Facility is placed, including but not limited to attachment, construction, digging, excavation, placement, pulling and the like.
18. **License** means a nonexclusive specific authorization granted pursuant to Subtitle 5A of the Prince George's County Code to Construct, operate, and maintain a Small Wireless Facility in the Public Right-of-Way to provide wireless communication services within all, or a specified area of, Prince George's County, Maryland. Any such authorization, in whatever form granted, shall not mean or include any general License or Permit required for the privilege of transacting and carrying on a business within the County as required by the ordinances and laws of the County, or for attaching devices to Poles or other structures, whether owned by the County or a private entity, or for excavating or performing other work in Public Right-of-Way.
19. **Licensee** means a natural Person, partnership, domestic or foreign corporation, association, joint venture, or organization of any kind that has been granted a Master License Agreement by the County, subject to Subtitle 5A of the Prince George's County Code.
20. **Material Change** means a change that does not qualify as an Eligible Facilities Request as defined by the FCC.
21. **Master License Agreement** means a written agreement entered into pursuant to Subtitle 5A of the Prince George's County Code between the County and a Licensee that sets forth the terms and conditions under which a License will be granted and exercised.
22. **Minor Antenna** means a radio/Antenna device no more than twenty (20) inches in length, ten (10) inches in width, and ten (10) inches in height (excluding mounting



brackets, fasteners, cabling, and Antenna) with two (2) watts or less of transmitter output power which is mounted on a strand, cable or wire attached to pre-existing Poles, so long as:

- a. The device is installed in a manner that does not result in line sag; and
- b. The device is located on a strand, cable or wire owned or controlled by the owner of the minor radio/Antenna device; and
- c. There are no more than two (2) said devices at any location or mid strand between two Poles; and
- d. The device is installed in parallel with the adjacent roadway, and is not installed over the roadway; and
- e. The device complies with all applicable Federal, State and local regulations, including Subtitle 5A and Subtitle 23 of the Prince George's County Code.

23. **Minor Modification** means changes to an existing Telecommunications Transmission Facility that does not result in a Material Change to the existing Facility or Support Structure.

24. **Monopole** means a Tower that is a single, self-supporting Pole-type structure, tapering from base to top and bearing a fixture designed to support Telecommunications Transmission Facilities.

25. **Permit** means an official document or certificate issued by the Director or his duly authorized agent, authorizing performance of specified construction at a specified location and within a specified time, together with all supporting documents, agreements, conditions, plans, and specifications.

26. **Person** means any natural or corporate Person, business association or business entity including, but not limited to, an individual, a partnership, a sole proprietorship, a political subdivision, a public or private agency of any kind, a utility, a successor or assign of any of the foregoing, or any other legal entity.

27. **Pole** means a type of structure in the Public Right-of-Way that is used in whole or in part for wireline communications, electric distribution, lighting, traffic control, signage, or similar function, or for Co-location.



28. Private Property means any real property owned or controlled by a single individual or by a group of individuals collectively. Private Property is any property that is not Public Property.

29. Protected Area means a site that:

- a. has undergrounded utilities; or
- b. is proximate to a roadway in a residential zone; or
- c. as of the date of an Application, is located in a Historic District as that term is defined in Section 29-102(a)(7) of Subtitle 5A of the Prince George's County Code; or
- d. as of the date of an Application, is located within a group of buildings, properties, or on a site that is listed in Prince George's County Inventory of Historic Resources; or
- e. as of the date of an Application, is located within a group of buildings, properties, or on a site, that is listed in the National Register of Historic Places or formally determined eligible by the Keeper of the National Register; or
- f. as of the date of an Application, is located within a group of buildings, properties, or on a site that is listed in the Maryland Inventory of Historic Properties.

30. Proximate to Roadway means the area located adjacent to or part of the Public Right-of-Way that includes:

- a. any public utility easement; or
- b. privately owned and maintained road on which an easement for public access exists.

31. Public Property means any real property owned or controlled by the County or another public entity including buildings and may include surplus property as defined in Section 2-111.01 of the Prince George's County Code.

32. Public Right-of-Way means the surface and space above, on, beside and below any public highway, avenue, street, lane, alley, boulevard, concourse, driveway, bridge, tunnel, park, parkway, waterway, dock, bulkhead, wharf, pier, building, public



easement, right-of-way, or any other public ground or water within the unincorporated area of the County or one belonging to the County.

33. Radio Frequency Propagation Contour Maps (also referred to as **Coverage Maps**) mean maps that indicate coverage provided by a cell site at a specific geographical location. These maps illustrate target signal levels (set by the wireless service provider) with different colors. They are calculated using the most suitable propagation model for the operating frequency bands.

34. Small Wireless Facility (SWF) means a Facility that meets each of the following conditions:

a. The Facility

- i. is mounted on a structure 50 ft. or less in height, including the Antenna; or
- ii. is mounted on a structure no more than ten percent (10%) taller than other adjacent structures; or
- iii. does not extend the existing structure on which it is located to a height of more than 50 ft. or by more than ten percent (10%), whichever is greater.

b. Each Antenna associated with the Facility, excluding associated Antenna Equipment, is no more than 3 cu. ft. in volume;

c. All other wireless equipment associated with the structure, including the wireless equipment associated with the Antenna and any pre-existing associated equipment on the structure, is no more than 28 cu. ft. in volume;

d. The Facility does not result in human exposure to radio frequency radiation in excess of all applicable FCC safety standards.

35. Support Structure means a structure, including, but not limited to, buildings, Monopoles, Towers, Poles, Base Stations, and other free-standing self-supporting or guyed structures that may support telecommunications Facilities, whether or not the structure has an existing telecommunication Facility.



36. **Telecommunications** means the transmission, between or among points specified by the user, of information of the user's choosing without change in the form or content of the information as sent and received.
37. **Telecommunications Services** means the offering of telecommunications for a fee, by a Person, which the Person is authorized to provide under applicable Federal, State, and local law, regardless of the Facilities used. It includes, without limitation, transmission by optical fiber, coaxial cable, wireless methods, or any other means, and includes, without limitation, voice, video, data, telephone service, cellular service, and personal communications services.
38. **Telecommunications Transmission Facility** means any Antenna and/or Support Structure which is used to transmit or retransmit wireless voice, data, or image information, but shall not mean or include a Minor Antenna. A Small Wireless Facility is a Telecommunications Transmission Facility.
39. **Telecommunications Transmission Facility Coordinating Committee (TFCC)** means the committee established in accordance with Section 5A-153 of the Prince George's County Code.
40. **Tower** means any supporting structure built for the sole or primary purpose of supporting any FCC-licensed or authorized Antennas (and related Facilities), including supporting structures that are constructed for FCC-licensed or authorized wireless communications including, but not limited to, private, broadcast, and public safety services, as well as unlicensed wireless services and fixed wireless services such as microwave backhaul, and the associated site. This definition does not include a Pole.
41. **Underground Facility Area** means any area where there are currently no above-ground utility Facilities, or an area that has been designated by the County as an area where only underground utility Facilities can be placed, including a County-designated underground District.
42. **Underground Requirement Area** means an area where Poles, utility Poles, overhead wires, and associated overhead or above ground structures have been removed and buried or have been approved for burial underground pursuant to municipal ordinances, zoning regulations, state law, private deed restrictions, and other public or private restrictions, that prohibit installing above ground structures in a Public Right-of-Way.



43. **Wireless Communication System** means all or any part of a Facility that is licensed by the Federal Communications Commission under Title 47, Code of Federal Regulations, Parts 20, 22, 24, 90, or 101, and is located in whole or in part on Public Property and/or public rights-of-way and is used to provide one or more telecommunications services.

44. **Wireless Facility Owner** means a Person who owns or operates a Small Wireless Facility.



SECTION 3 POLE-MOUNTED SMALL WIRELESS FACILITY

As of the date of this version of the Design Manual, typical Pole-mounted small wireless equipment comprises:

1. Antennas on the upper part of the Pole;
2. Radios, fiber terminations, and other equipment located in enclosures or cabinets or within the Pole;
3. A power meter and power disconnect switch may be installed as two separate, smaller enclosures on or within the Pole. In any design configuration, the power meter and power disconnect switch must be located on a portion of the Pole that is not exposed to radio frequency radiation in excess of the applicable FCC safety standards and when located on a utility Pole, must maintain compliance with the National Electric Safety Code (NESC).

Figure 1 through *Figure 3* are conceptual drawings intended to demonstrate the basic elements of a Small Wireless Facility attachment and how they typically fit together. The drawings are not-to-scale, nor representative of actual structures.

Figure 1 is an illustration of a Small Wireless Facility on a wood utility Pole. *Figure 2* illustrates a Small Wireless Facility on a steel Pole with Pole-mounted cabinet and equipment. *Figure 3* shows a Small Wireless Facility on a customized steel Pole, designed to conceal the cabinet and equipment at the base of the Pole.

County-specific typical design configurations are provided in *Appendix A*. Each Small Wireless Facility Applicant shall have County pre-approved plans-on-file, or shall submit detailed designs, sealed by a Professional Engineer, for County review and approval with each Permit Application.



Figure 1
CONCEPTUAL LAYOUT
WOOD UTILITY POLE WITH POLE-MOUNTED EQUIPMENT

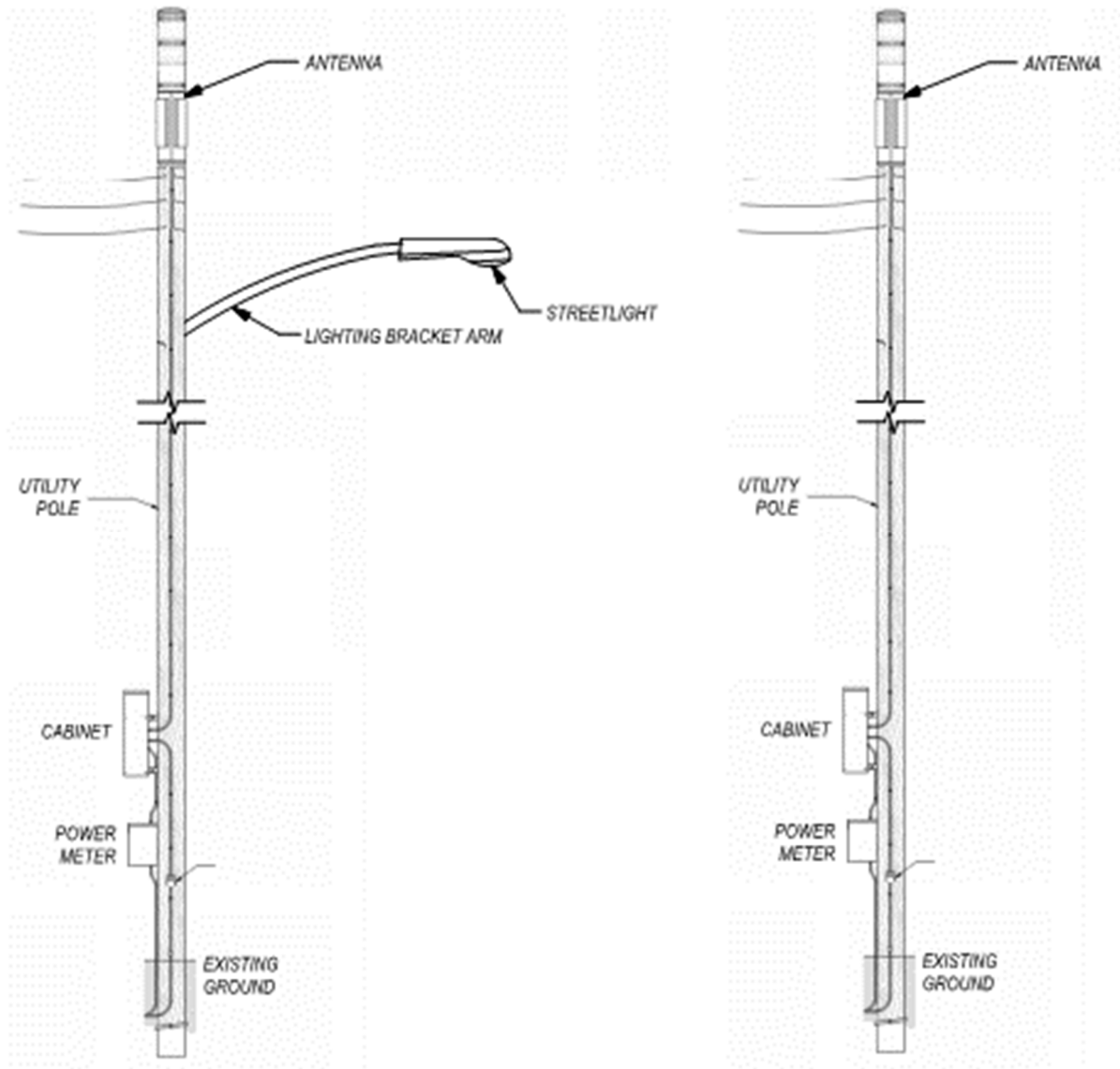



Figure 2
CONCEPTUAL LAYOUT
STEEL POLE WITH POLE-MOUNTED EQUIPMENT

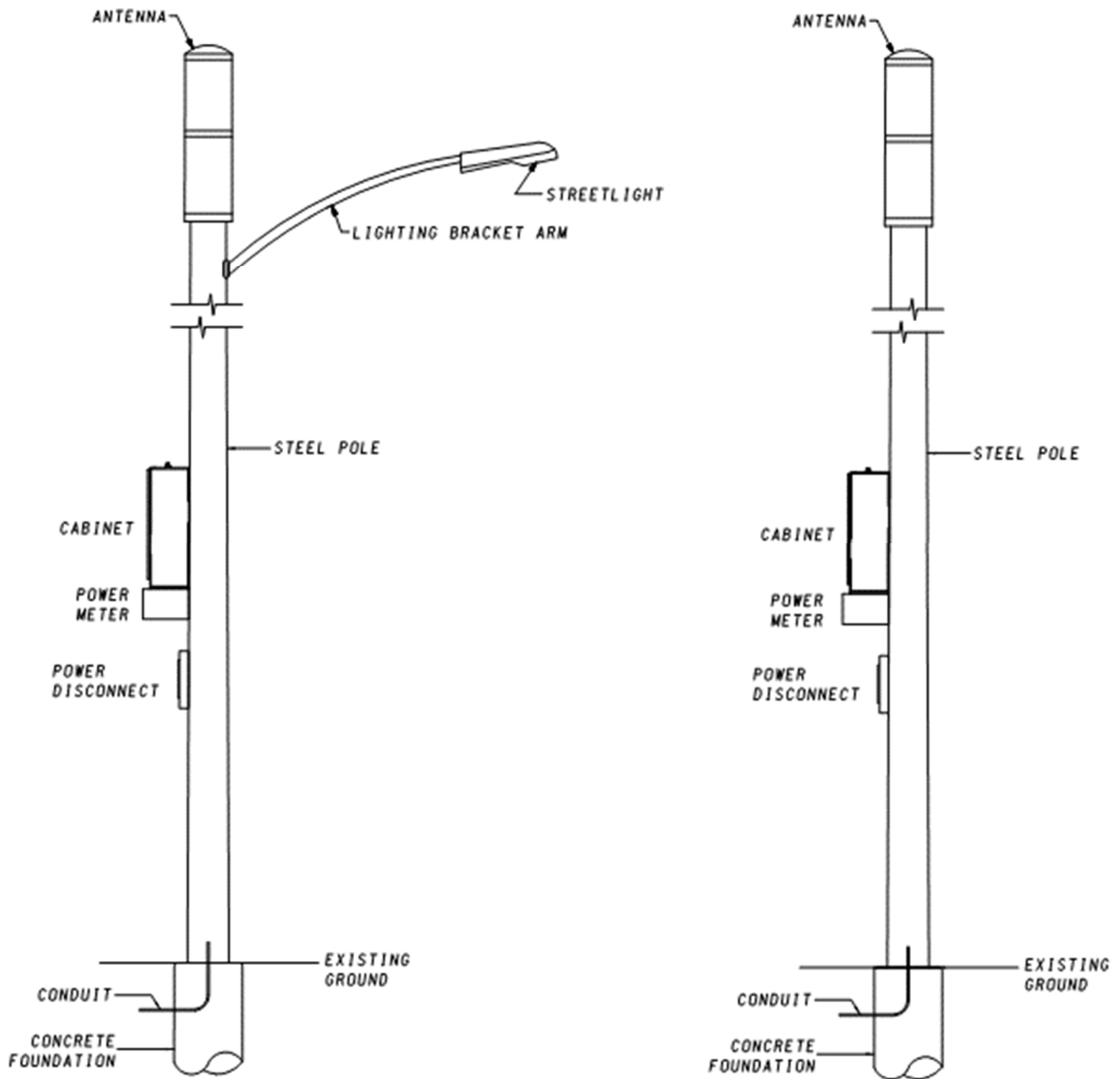
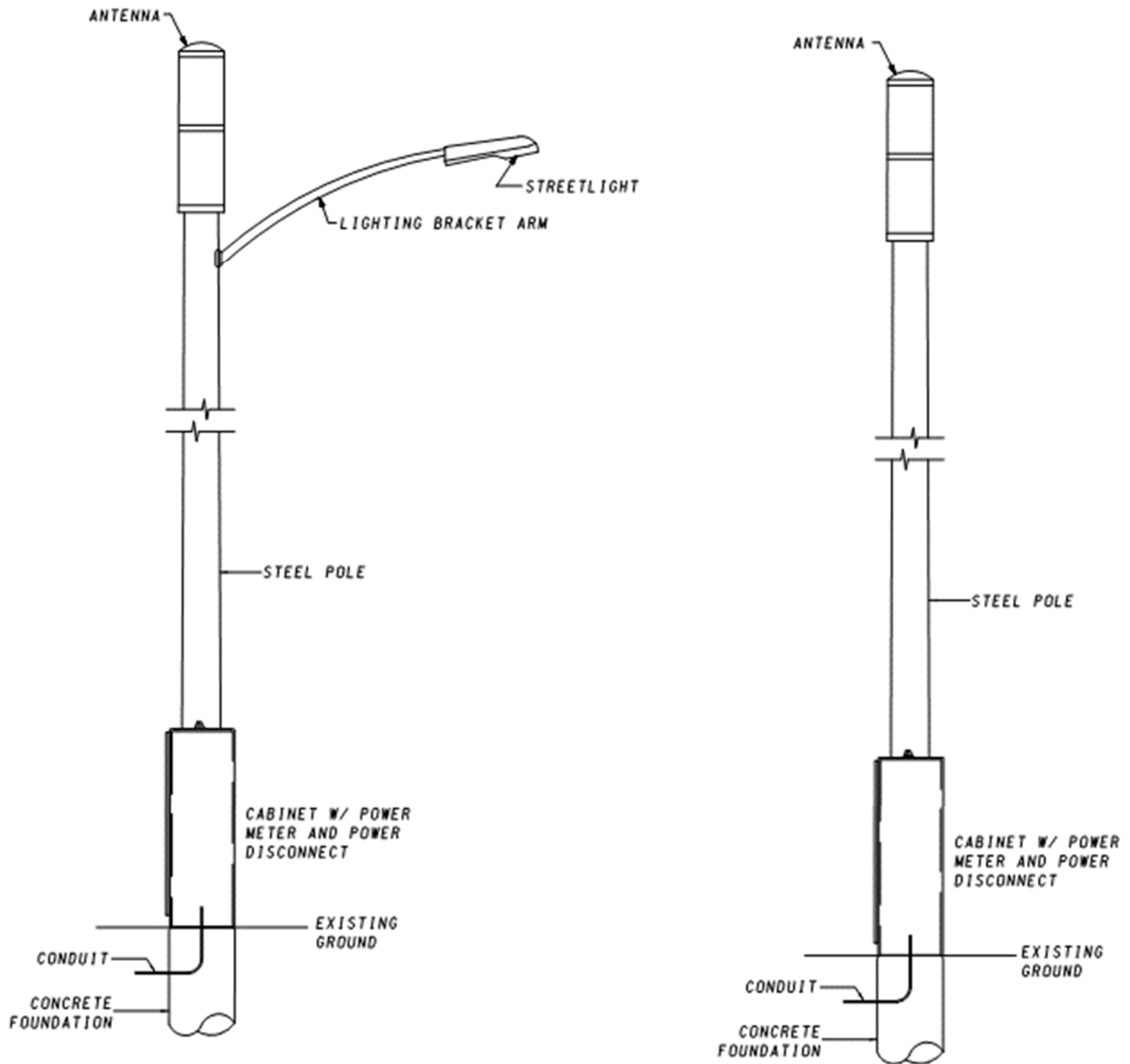



Figure 3
CONCEPTUAL LAYOUT
STEEL POLE WITH CONCEALED EQUIPMENT AT POLE BASE





SECTION 4 APPLICATION TYPES

An Applicant may apply for a Minor Modification, Co-location, replacement, or new structure. The following are requirements for the three (3) primary types of Small Wireless Facility Applications that the County anticipates receiving, i.e. Co-location, Replacement Pole, and New Pole Applications:

4.1 *Co-location Application for a Pre-existing Structure*

An Application to co-locate on an existing structure is subject to the provisions of Section 5A-159 of the Prince George's County Code.

- 4.1.1 A Small Wireless Facility shall not be attached to an existing decorative Pole, which is defined as a structure that is specially designed and placed for aesthetic purposes and on which no appurtenances or attachments, other than lighting, specially designed informational or directional signage, or temporary holiday or special events attachments, have been placed.
- 4.1.2 Existing County streetlight Poles are not designed to support Small Wireless Facilities. An Applicant seeking to attach to an existing County streetlight Pole must provide the functionality of the existing Pole and ensure that it is designed to support a Small Wireless Facility.

4.2 *Replacement Pole Application*

An Application for a replacement Pole is subject to the provisions of Section 5A-159 of the Prince George's County Code.

- 4.2.1 A County-owned Pole replacement should use one of the standard designs in *Appendix A*.
- 4.2.2 In the case of the Applicant replacing a non-decorative Pole, the preference is to use **Design 1** if it can provide the technical capability required by the Applicant. If the Applicant can demonstrate that Design 1 cannot provide the required technical capability, **Design 2** should be used. If Design 2 cannot be used in the proposed environment due to ADA requirements or space restrictions in the Public Right-of-Way, the Applicant should use **Design 3**.



- 4.2.3 In the case of the Applicant replacing a decorative Pole, the Applicant should use a Pole that matches the decorative Pole being removed. If that cannot be achieved, the Applicant should use **Design 4**.
- 4.2.4 Replacement Poles, other than streetlight Poles, must be installed within 10 ft. of the original Pole and should maintain the same distance to the curbs and sidewalks as other Poles in the area.
- 4.2.5 The Applicant shall minimize the size and aesthetic differences between a replacement structure and the original Pole or structure.
- 4.2.6 A replacement streetlight Pole shall be installed in the same location as the original Pole, as close as possible to the line between the residential or business lots. It shall serve the same primary purpose of the original Pole, which is the provision of lighting in the designated area.
- 4.2.7 Temporary lighting shall be provided when a replacement streetlight Pole is being installed. The temporary lighting must be provided for the duration of the construction and removed only when the new streetlight becomes operational.
- 4.2.8 The Applicant shall cause a pre-existing utility Pole to be removed within ninety (90) days after a replacement utility Pole is installed.
- 4.2.9 Replacement Poles should be designed to account for and support loading of 400 lbs. of future County-owned equipment, to be installed on the Pole at the County's request.

The County will conduct an additional review of the Application for a replacement structure to determine:

- 4.2.10 The demonstrated need for replacing the structure at the requested location, and that the Applicant has demonstrated that there are no other effective technological means for co-locating on a pre-existing structure.
- 4.2.11 Whether the appearance and placement of the requested structure is aesthetically consistent with the immediate area.
- 4.2.12 The Applicant's technical objectives and whether the Applicant should use available or previously unconsidered alternate locations to place the Support Structure or Small Wireless Facility.



4.3 New Pole Application

An Application for a new Pole is subject to the provisions of Section 5A-159 of the Prince George's County Code.

- 4.3.1 The new Pole should use one of the standard designs in *Appendix A*. The County requires that no aerial cables are run to new Poles. All power and backhaul connections must be fed from underground.
- 4.3.2 New wooden Poles, except as a replacement for an existing utility Pole, are prohibited.
- 4.3.3 Poles and light fixtures should match or complement the surrounding precedent.
- 4.3.4 New Poles should be located within the same distance to curbs and sidewalks as other Poles in the area.
- 4.3.5 New Poles should be designed to account for and support loading of 400 lbs. of future County-owned equipment, to be installed on the Pole at the County's request.

The Applicant shall also provide the following additional information with the Application to Install a new Pole:

- 4.3.6 Justification for the selected site. Describe the purpose of the site and, if applicable, why the proposed Small Wireless Facility is not being co-located.
- 4.3.7 A photographic simulation of the structure and equipment from at least two (2) different directions and approximately ¼-mile away. If the new structure is visible from adjoining parcels, include views from the adjoining parcels.
- 4.3.8 Data for any drive tests that were performed, including a note that the results are attached.
- 4.3.9 Radio Frequency Propagation Contour Maps (if the justification is coverage-oriented) showing the site with and without the Small Wireless Facility. The maps should show calculated signal levels in color at the target signal level and plus and minus ± 5 dB. Include a legend indicating the signal levels represented by each color. Include maps showing coverage at the proposed Antenna elevation and at 10 ft. below the proposed elevation. The maps



must be legible and contain sufficient detail to show neighborhood streets around the proposed site and adjacent sites.

- 4.3.10 Evidence of Capacity exhaustion of the current serving site (if the justification is capacity-oriented). The evidence must demonstrate that the Capacity at the serving site will be diminished within eighteen (18) months of the Application such that it will have a negative impact on the users within the area if new Capacity is not added. Examples of this may include time-of-day download speeds, utilization over time, or cumulative Key Performance Indicator (KPI) reports from the serving site.
- 4.3.11 Engineering design and specification drawings in compliance with the most recent version of the County's Department of Public Works and Transportation *Policy and Specification for Utility Installation and Maintenance*, including Appendix E.1, *Policy and Standards for Small Wireless Facility Installation and Maintenance*, and this Design Manual.

In all cases, Small Wireless Facilities and associated Support Structures shall be located to avoid any physical or visual obstruction to pedestrian or vehicular traffic or any other safety hazards to pedestrians, cyclists, or motorists. If the County determines that a proposed location would present any such hazards, the County shall require the Applicant to choose an alternate site.

The County will conduct an additional review of the Application for a new structure to determine:

- 4.3.13 The demonstrated need for placing the structure at the requested location, and that the Applicant has demonstrated there are no other effective technological means for delivering the service.
- 4.3.14 The impact of placing a new structure or Facility in the subject area.
- 4.3.15 The character of the area in which the structure is requested, including surrounding buildings, properties, and uses.
- 4.3.16 Whether the appearance and placement of the requested structure is aesthetically consistent with the immediate area.



4.3.17 The Applicant's technical objectives and whether the Applicant should use available or previously unconsidered alternate locations to place the Support Structure or Small Wireless Facility.



SECTION 5 SMALL WIRELESS FACILITY LOCATIONS

Pursuant to Section 5A of the Prince George's County Code, deployment of Small Wireless Facilities must adhere to the following requirements:

1. Small Wireless Facility Poles shall be installed with a minimum 30 ft. setback from residential buildings as measured from the center point of the side of the building closest to the property line, to the Support Structure.
2. A Small Wireless Facility shall not be located within 15 ft. of an existing tree. Additionally, installation or mounting must be performed in a manner that attempts to preserve the existing tree canopy.
3. A single Wireless Facility Owner's Small Wireless Facilities shall be installed with a minimum spacing of 150 ft.
4. No Small Wireless Facility shall be installed within 250 ft. of an elementary or secondary educational institution.
5. Any Small Wireless Facility installed within the Public Right-of-Way or within an easement shall be in alignment with the existing vertical infrastructure, streetlights, utility Poles, and trees and shall not be closer than 3 ft. – 6 in. from the curb, or 6 ft. from the edge of the paved roadway section if no curb exists.

The following additional preferences should be observed, in order of the listed preference:

6. Poles should be installed with a minimum 20 ft. setback from commercial buildings as measured from the center point of the Support Structure.
7. In all cases, the replacement of Small Wireless Facilities should be consistent with existing structures and aesthetics; in harmony with the surroundings; and be as non-obtrusive as possible. For example, in areas with decorative streetlight Poles, Small Wireless Facilities on streetlight Poles must be consistent in appearance with existing decorative streetlight Poles, requiring designs comparable in scale and incorporating design characteristics of the decorative streetlight Pole being replaced.



8. A non-County-owned replacement Pole should be installed within 2 ft. of the original Pole location, as close as possible to the line between residential or business lots. It shall serve the purpose of the original Pole (i.e., lighting) while also serving as a Support Structure for the Small Wireless Facility.
9. No Small Wireless Facility should extend over the roadway.
10. No Small Wireless Facility should be installed in a Public Right-of-Way within 250 ft. of a Park.



SECTION 6 TECHNICAL AND AESTHETIC REQUIREMENTS

All Small Wireless Facilities shall utilize stealth and Concealment methods to limit their visual impact when feasible. Stealth features should include blending with the environment, concealing the equipment and Antennas, and limiting the overall size including the height.

In using this Design Manual, Applicants must follow Subtitle 5A and 23 of the Prince George's County Code; the *Policy and Specification for Utility Installation and Maintenance*, including Appendix E.1, *Policy and Standards for Small Wireless Facility Installation and Maintenance*; and the *Department of Public Works and Transportation Specifications and Standards for Roadways and Bridges (2012)*.

6.1 Prohibited Structures

- 6.1.1 Small Wireless Facilities shall not be installed on Poles containing controls such as fire alarms, police signals or traffic signals.
- 6.1.2 Small Wireless Facilities shall not be placed where they conflict with existing or planned County projects. All inquiries into future projects will be addressed by the County's Department of Public Works and Transportation, Office of Engineering and Project Management; and the Office of Information Technology.

6.2 Right-of-Way

Small Wireless Facilities and wireless Support Structures shall be constructed and maintained in a manner that:

- 6.2.1 Does not obstruct, impede, or hinder the usual travel or public safety on a Public Right-of-Way.
- 6.2.2 Does not obstruct the legal use of a Public Right-of-Way by any public or private utility providers.
- 6.2.3 Does not impede, obstruct, violate, conflict with, or hinder any mode of travel or access to the Public Right-of-Way, an alley, or driveway.
- 6.2.4 Does not obstruct any access to any fire escape, fire hydrant, doors, gates, stoops, public transportation vehicles, shelters, street furniture or other



improvements at any public transportation stop (including, without limitation, bus stops, streetcar stops, and bike-share stations).

- 6.2.5 Does not obstruct the sight line of any alley or driveway, and a minimum of 15 ft. shall be maintained between the Pole and the outside edge of the alley or driveway and 25 ft. from intersecting street.
- 6.2.6 Does not obstruct public works projects and submits the Small Wireless Facility design to temporary installation, if necessary, to facilitate the unimpeded construction of the public works project(s).

In addition to the previously mentioned construction and maintenance guidelines for Small Wireless Facilities within the Public Right-of-Way,

- 6.2.7 Applicants shall repair any damage to Public Right-of-Way caused by work performed by or on behalf of the Applicant and/or Wireless Facility Owner and shall return the work area to the original right-of-way condition.
- 6.2.8 Poles installed within the Public Right-of-Way in a Protected Area and proximate to a roadway in Protected Area shall not exceed 30 ft. in height.
- 6.2.9 Poles installed within the Public Right-of-Way shall not exceed the greater of 50 ft. or 10 ft. greater than the tallest existing Pole in the Public Right-of-Way.

6.3 *Electric Supply and Backhaul Connections*

- 6.3.1 Based on a County pre-approved process, the County shall have access to the power meter and power disconnect switch in the event that Emergency services need to access and de-energize a Small Wireless Facility.
- 6.3.2 The Small Wireless Facility may be connected via wireless backhaul services. The volume and height of any Antenna used for wireless backhaul services is counted toward the maximum height of the Pole.
- 6.3.3 Each approved Small Wireless Facility installation shall have a clearly marked power disconnect switch adjacent to the electronics cabinet. Once the shut-off switch is placed in the "open" position, the electronics equipment related to the Small Wireless Facility installation shall not be energized and no radio frequency transmissions shall be emanating from any Antenna related to the Small Wireless Facility.



6.4 *Ground Equipment*

- 6.4.1 Must not exceed a maximum volume of 20 cu. ft., a maximum width of 26 in. and a maximum height of 48 in.
- 6.4.2 Must be painted or screened to be the same color or design as the pre-existing structure or of the new structure being installed.
- 6.4.3 May be placed inside the Pole, such as in the base of the Pole in a way that integrates with the design of the Pole.

6.5 *Pole-Mounted Equipment*

- 6.5.1 Shall use tapered or contoured designs, instead of a rectangular box-shape design.
- 6.5.2 The County prefers the use of stealth design elements, such as shapes and colors that match surrounding infrastructure and minimize adverse visual impacts. In accordance with Subtitle 5A, Protected Areas must utilize the stealth design.
- 6.5.3 Must be flush-mounted or mounted as near as possible to the Pole, accounting for any remaining space that is required for the mounting brackets.
- 6.5.4 Must not exceed a maximum volume of 9 cu. ft. and a maximum width of 2 ft. Cabinets that are non-rectangular in shape must be comparable or less in volume and visual impact.
- 6.5.5 Must be a minimum of 10 ft. above ground level.
- 6.5.6 Must be on the side of the Pole facing away from the roadway.
- 6.5.7 Cabinets may either be Pole-mounted or ground-mounted on a concrete slab within 50 ft. of the Pole where the Small Wireless Facility is installed.
- 6.5.8 Ground-mounted cabinets must be of the same color as other nearby pedestals or cabinets. Where there are no other nearby pedestals or cabinets, ground-mounted cabinets should be of the same color as the Pole housing the Antenna.

6.6 *Placement of Facilities*

- 6.6.1 Advertising on Support Structures or equipment is prohibited.



- 6.6.2 In hollow structures, the wiring and cables should be housed within the Support Structure Pole and extended vertically within flexible conduit.
- 6.6.3 Spools and/or coils of excess fiber optic or coaxial cables or any other wires shall not be stored on the Pole except completely within the approved enclosures or cabinets.
- 6.6.4 Signs or illumination on the Antennas or Support Structure are prohibited unless required by the FCC, the Federal Aviation Administration, or the County.
- 6.6.5 Small Wireless Facilities, wireless Support Structures and related ground equipment shall not impede pedestrian or vehicular traffic in the Public Right-of-Way. If any Small Wireless Facility, wireless Support Structure or ground equipment is installed in a location that is not in accordance with the plans approved by the County and impedes pedestrian or vehicular traffic, or does not comply with or otherwise renders the Public Right-of-Way non-compliant with applicable laws, including the Americans with Disabilities Act, then the Wireless Facility Owner shall, upon written notice of the violation, promptly, i.e. within a period no greater than twenty-five (25) working days, remove the Small Wireless Facility, wireless Support Structure, and/or ground equipment.
- 6.6.6 A distinct marker (tag) shall be placed on Small Wireless Facilities that will allow the ready identification of the type of attachment, its owner, and contact information. The marker shall be limited to a 6 in. X 4 in. plate.
- 6.6.7 On non-wooden Poles, all cables shall be placed inside the Pole and shall not be visible on the outside of the Pole.
- 6.6.8 All Antennas must be placed in-line with or be flush-mounted with the Pole.
- 6.6.9 Removal and relocation by the Wireless Facility Owner of its Small Wireless Facility, wireless support Pole, or related ground equipment at its own discretion, shall be in strict accordance with the County's Code and Master License Agreement.
- 6.6.10 The Wireless Facility Owner understands and acknowledges that the County may require the Wireless Facility Owner to remove or relocate its Small Wireless Facility, wireless Support Structure, and related ground equipment,



or any portion thereof from the Public Right-of-Way for County construction projects as allowed by the Prince George's County Code and Master License Agreement.

6.6.11 When Antennas are placed in-line with the Pole, Antennas must have a smooth cylindrical shape, i.e. ideally, a single canister; or multiple separate Antennas placed inside sheathing that is flush with the Pole; or of a form factor design in which multiple Antennas merge into a single smooth shape that conforms to the space requirements of the Pole on which it is mounted. No separately mounted Antennas will be allowed on a single installation, e.g. as with physically separate panel Antennas for each sector.

6.6.12 Antennas on streetlight Poles must be the same color as the Pole. Antennas on wooden utility Poles must be a neutral, unobtrusive color, e.g. black, brown, dark green, etc.

6.6.13 Antenna attachments are limited to the following types and dimensions:

1. Small Antennas enclosed in a canister must have a combined maximum height of 4 ft. and a maximum total volume of 9 cu. ft.
2. Small Antennas enclosed in a panel must have a combined maximum height of 3 ft. and a maximum total volume of 3 cu. ft.

6.7 *Wooden Utility Poles*

The technical standards of the utility Pole owners shall govern the installation of Small Wireless Facilities on these types of Support Structures. In addition, the County requires the following:

1. Riser Cable: Riser cables to connect Antennas and Antenna accessory equipment, backhaul services, and power lines on wooden utility Poles shall be in conduit on the side of the Pole facing away from the roadway.
2. Conduit Requirements: Conduits shall be a neutral color or a color matching the Pole. No riser cable slack shall be stored externally. All slack shall be stored in junction boxes or equipment cabinets or on "snowshoes" on the aerial cable.
3. Cabinets: Cabinets are allowed on the side of wooden utility Poles facing away from the roadway.



SECTION 7 UNDERGROUNDING

The Wireless Facility Owner shall comply with nondiscriminatory undergrounding requirements, including County ordinances, zoning regulations, state law, private deed restrictions, and other public or private restrictions, that prohibit installing above-ground structures in a Public Right-of-Way without first obtaining zoning or land use approval. Areas may be designated from time to time by the County as Underground Requirement Areas in accordance with filed plats, and/or conversions of overhead to underground areas, as allowed by Law. In addition, the Wireless Facility Owner and/or Applicant must follow Subtitles 5A and 23 of the Prince George's County Code; the *Policy and Specification for Utility Installation and Maintenance*, including Appendix E.1, *Policy and Standards for Small Wireless Facility Installation and Maintenance*; and the *Department of Public Works and Transportation Specifications and Standards for Roadways and Bridges (2012)* to comply with all undergrounding requirements and with minimum acceptable clearances between Small Wireless Facility infrastructure and other existing nearby Facilities. Each Application shall disclose if it is within an area that has undergrounding requirements. The County prefers that the Applicant Install any additional conduit so that it runs parallel to Wireless Facility Owner's fiber optic cable.



SECTION 8 RADIO FREQUENCY EXPOSURE

Applicants shall comply with all provisions and guidelines of FCC Office of Engineering & Technology (OET) Bulletin 65 or its successor document(s), including all current, applicable amendments.

Upon request, the Applicant shall perform radio frequency field tests while the Small Wireless Facility is in operation, supervised by the County, to demonstrate compliance with FCC OET Bulletin 65.

8.1 Radio Frequency Signage Requirements

Approved signage compliant with FCC OET Bulletin 65 shall be posted at each Pole supporting a Small Wireless Facility, and/or at multiple locations on such Support Structure as required by FCC OET Bulletin 65. The radio frequency signage shall comply with the appropriate and predetermined exposure level(s) applicable to the General Public, Occupational Workers, and Specialized Workers as shown in *Figure 4* below. All signage shall be 8 in. x 12 in. and shall be made of weather-, corrosion-, and ultraviolet (UV)-resistant materials.

Figure 4
RADIO FREQUENCY SIGNAGE

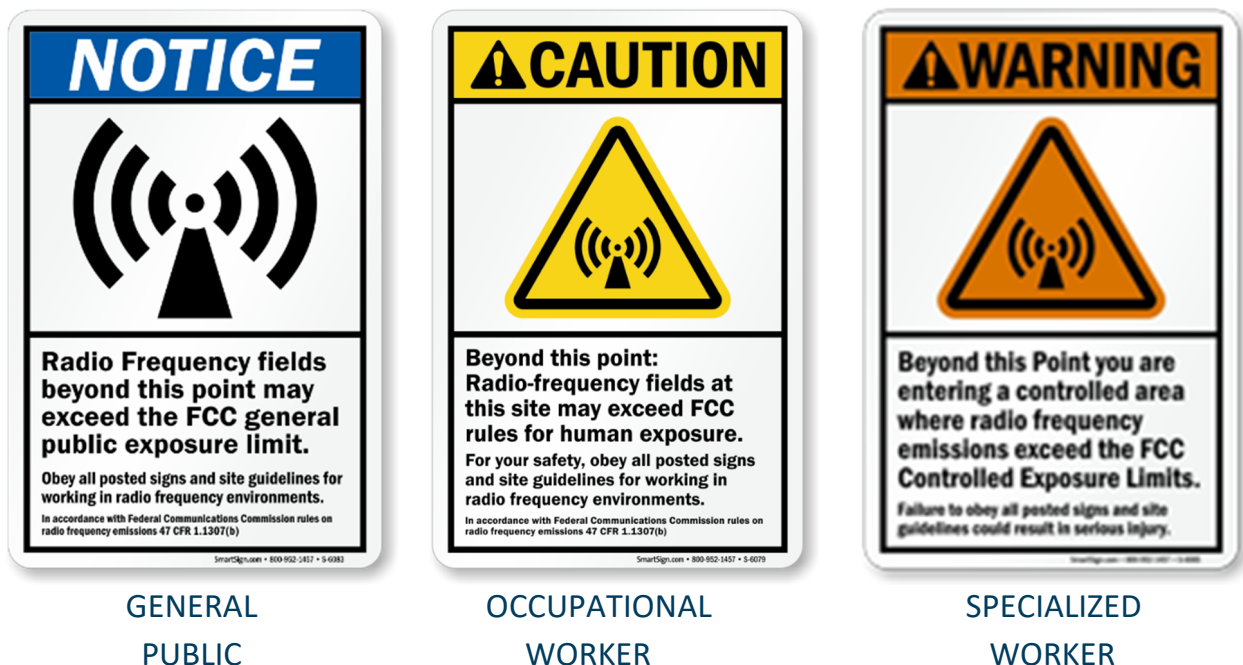



8.2 *Emergency Radio Frequency / Power Shut-Off*

Each approved Small Wireless Facility shall have a clearly marked power disconnect switch adjacent to the electronics cabinet and located outside areas that exceed radio frequency exposure limits. Once the shut-off switch is placed in the “open” position, the electronics equipment related to the Small Wireless Facility installation shall not be energized and no radio frequency transmissions shall be emitted by any Antenna. If the County determines that the Small Wireless Facility is interfering with public safety communications, the County at its sole discretion, may shut it off using the power shut-off switch and then notify the owner.

8.3 *Licensed Frequencies*

Antennas shall only transmit or receive frequencies that are licensed by the FCC to the Applicant or to the Wireless Facility Owner. If the Applicant wishes to add another wireless Carrier or change the wireless Carrier network using the Small Wireless Facility, the Applicant shall notify the County in writing of the change in wireless Carrier and frequencies. Frequency bands listed by the FCC as unlicensed and available for open use may be transmitted or received, if they do not cause interference with another existing Wireless Facility Owner, and FCC-licensed entity, or with the County. If the County experiences radio frequency interference, the Applicant or its successor shall pay for an expert third-party review, including the cost to remediate the interference. The County reserves the right to remove the Small Wireless Facility if the interference is not corrected.



SECTION 9 BACKUP POWER

Battery backup power devices shall be installed with a transfer switch to prevent back-feeding into the electrical system. No other types of backup power shall be permitted.

SECTION 10 LIGHTING AND NOISE

1. No panel or LED lighting may be visible on Small Wireless Facilities equipment, e.g. cabinets. If there are lights on the supplied equipment, they must be covered, removed, or deactivated.
2. Small Wireless Facilities must comply with the County's Noise Ordinance.
3. Antennas and equipment should be passively cooled. However, should a base cabinet require active cooling, it must comply with the County's Noise Ordinance.
4. Applicants are required to incorporate noise-suppression measures with the installation of Small Wireless Facility equipment, or place equipment in locations where noise is less likely to impact adjacent residences and businesses to ensure compliance with all applicable noise regulations and Ordinances.



SECTION 11 APPLICATION SUBMITTALS

The chart below (*Figure 5*) indicates the required submittals that must accompany an Application for a Small Wireless Facility. The submittal requirements are identified for each Application type.

11.1 Radio Frequency Analysis

As a condition of approval for attachments on all Poles, Applicants shall provide an evaluation of proposed wireless equipment being attached to the Pole to prove its compliance with FCC guidelines for human exposure to radio frequency fields. Evaluations shall include uncontrolled exposure in the near-field and far-field regions. Additional evaluations shall be provided whenever the transmitting power of existing equipment is increased. The evaluations shall document existing radio frequencies, proposed radio frequencies and summarize possible radio-frequency interference. If the County proposes to Install equipment that would operate within the same radio frequency as an existing attachment, the attachment shall be relocated at the sole expense of the attachment owner. The attachment owner shall remove the attachment within twenty-five (25) working days after receiving a notice from the County. Any attachment that remains in-place after the twenty-five (25) working days have elapsed shall be considered an unauthorized attachment.



Figure 5
REQUIRED SUBMITTALS BY APPLICATION TYPE

SUBMITTAL REQUIREMENT	DESCRIPTION	APPLICATION TYPE			
		NEW	REPL.	MINOR MOD	CO-LOC.
COMPLETE APPLICATION		✓	✓	✓	✓
CONSTRUCTION DRAWING		✓	✓	✓	✓
MOT PLAN / TCP	Traffic Control Plan for installations impacting drive lanes or sidewalks.	✓	✓	--	--
APPROVED E&SC PLAN	Erosion and Sediment Control plan for installations with ground disturbance exceeding 5,000 SF.	✓	✓	--	--
ROW RESTORATION PLAN	Plan showing sod/turf grass establishment or appropriate ROW restoration.	✓	✓	--	--
MAP	Attach map of the general area, showing the location of the site	✓	✓	✓	✓
MANUFACTURER SPECIFICATIONS	Upload manufacturer's cut-sheets for all proposed radios, Antennas and accessories listed above in "Antenna Specification and Installation"	✓	✓	✓	✓
RF PROPAGATION STUDIES	<ul style="list-style-type: none"> ▪ Provide copy of RF propagation contour maps showing site with/without calculated signal levels in color at the target signal level, and ± 5dB. ▪ Include a legend that shows what signal each color represents. ▪ Include maps showing coverage at the proposed Antenna elevation and at 20 ft. and 40 ft. below the proposed elevation. ▪ Maps must be legible and in sufficient detail 	✓	✓	--	--
DRIVE TEST DOCUMENTS	If drive tests were performed, provide copies of the data with the Application and note that they were attached.	✓	✓	--	--
PROPERTY OWNER CONSENT	<ul style="list-style-type: none"> ▪ Attach evidence that the owner has provided consent to use his/her structure for the proposed Small Wireless Facility. ▪ Include unique Pole number 	✓	✓	--	✓
PHOTOS / PHOTO SIMULATIONS	<ul style="list-style-type: none"> ▪ Provide a photographic simulation of the structure and equipment from at least two (2) different directions and approximately 1 mile away for Tower sites, and ¼ mile from nearer sites. ▪ If new site is visible from the adjoining parcel, include view from the adjoining parcel; ▪ Provide copies of photographs with balloon and results of simulation. 	✓	✓	--	--
STRUCTURAL ANALYSIS	If structural analysis was performed, attach here.	✓	✓	--	✓
RF Analysis	Attach if not categorically excluded from the report.	✓	✓	✓	✓



At a minimum, evaluations of proposed wireless equipment must contain the following:

1. A statement of compliance.
2. Date of the report.
3. Date of statement of compliance.
4. Pole number proposed for the Small Wireless Facility installation.
5. Applicant site or identification number for the Small Wireless Facility installation.
6. GPS coordinates of the existing or proposed Pole.
7. Calculation of radio frequency power at the radios or other electronics.
8. Calculation of radio frequency power at the Antennas.
9. Calculation of radio frequency power within 6 ft. of ground level, and at ground level.
10. Calculation of radio frequency power at windows of residences and businesses in closest proximity to the Small Wireless Facility.
11. Calculation of radio frequency power of the closest area that can be occupied by the general public in the main lobe of the Antenna, if within 50 ft.
12. Location of the applicable signage with above-ground-level height listed.

11.2 Structural Analysis

Pole loading analysis will need to be conducted, considering all equipment relating to the deployment of the Small Wireless Facility. The analysis will be based on the latest version of the AASHTO LRFD Specifications for Structural Supports for Highway Signs, Luminaires, and Traffic Signals, and the results, sealed by the Pole manufacturer's licensed Professional Structural Engineer, shall be provided. Also, foundation analysis shall be performed, and the results provided in a document sealed by a Professional Engineer licensed in the State of Maryland, certifying that the existing foundations in the field or the proposed foundation for replacement or new Poles can safely support the additional load from the attached wireless equipment. A thirty percent (30%) load-bearing factor of safety must be allowed for each structure.



11.3 Construction Drawings

The Wireless Facility Owner and/or Applicant must follow Subtitles 5A and 23 of the Prince George's County Code; the *Policy and Specification for Utility Installation and Maintenance*, including Appendix E.1, *Policy and Standards for Small Wireless Facility Installation and Maintenance*; and the *Department of Public Works and Transportation Specifications and Standards for Roadways and Bridges (2012)* to comply with all undergrounding requirements and with minimum acceptable clearances (5 ft. horizontal; 1 ft. vertical) between Small Wireless Facility infrastructure and other existing nearby Facilities.

11.3.1 General

All design documentation shall be submitted electronically with an Application and shall fully depict the scope of work to be performed by the Applicant.

The Applicant shall include in the design documentation, the Pole or Support Structure design; the Small Wireless Facility design details; and any other attachments such as fiber demarcations, battery backup, and power meters. Design documentation shall include any handholes, manholes, pedestals, demarcation enclosures, splice cases, and conduits surrounding the Small Wireless Facility and shall illustrate how the backhaul and power will interconnect with the Small Wireless Facility.

Design documentation shall be specific to the location and design described in the scope of work and shall not contain handwritten or superimposed annotations other than the Professional Engineer's signature and stamp, where required. Design documentation containing strictly generic typical details and typical sections will not be accepted. Design documentation shall be original-plotted digital renderings created with computer-aided design (CAD) software and presented in PDF file format. No individual document may be larger than 5 MB in size. Design documentation of poor visual quality – as determined by the County reviewer – may not be accepted.

Location information must be provided, which shall include the 911 address of the proposed Pole; Global Positioning System (GPS) coordinates of the proposed Pole; and the location of the wireless equipment attachment. An electronic Geographic Information System (GIS) map identifying the location of the proposed Pole, adjacent Pole infrastructure, County-owned radio frequency equipment within a 300 ft. radial distance, and nearby historic landmarks shall be provided.



The wireless equipment attachment details shall include in-depth information about proposed installation methods for all equipment relating to the deployment of a Small Wireless Facility. The attachment details shall also identify the existing Pole infrastructure that is proposed for use. Innerduct shall be utilized for installing service cable(s). Except for wooden utility Poles, underground conduit entry into the Pole infrastructure shall be the only permitted access for installing service cable(s).

11.3.2 Paper Size

All design documentation shall be legible when printed on 24 in. X 36 in. paper.

11.3.3 Abbreviations

All annotations, callouts, notes, and descriptive text shall be in plain language. If abbreviations are used to promote clarity in the design documentation, the Applicant shall follow the standards outlined in the County Department of Public Works and Transportation Specifications and Standards for Roadways and Bridges (2012).

11.3.4 Line Weights and Annotations

Descriptions of existing above-ground features on plan view and profile view sheets shall have a consistent line weight. Descriptions of existing below-ground utilities and features shall have a consistent line weight that is “screened” or lighter than existing above-ground features. All features and components of the proposed Small Wireless Facility – as opposed to existing conditions – shall have a consistent, heavier line weight than existing above-ground features. All annotations for the proposed Small Wireless Facility shall have a bold appearance and shall be noticeably heavier than other annotations on the plan view and profile view sheets. Line weights, annotations, legends, symbology and all required plan features must adhere to CADD Standards in the County *Department of Public Works and Transportation Specifications and Standards for Roadways and Bridges (2012)*.

Example plan view and profile view sheets with suitable line weights and annotations are shown in *Figure 6* and *Figure 7*, respectively.



Figure 6
SAMPLE PLAN VIEW
SUITABLE LINE WEIGHTS AND ANNOTATIONS¹

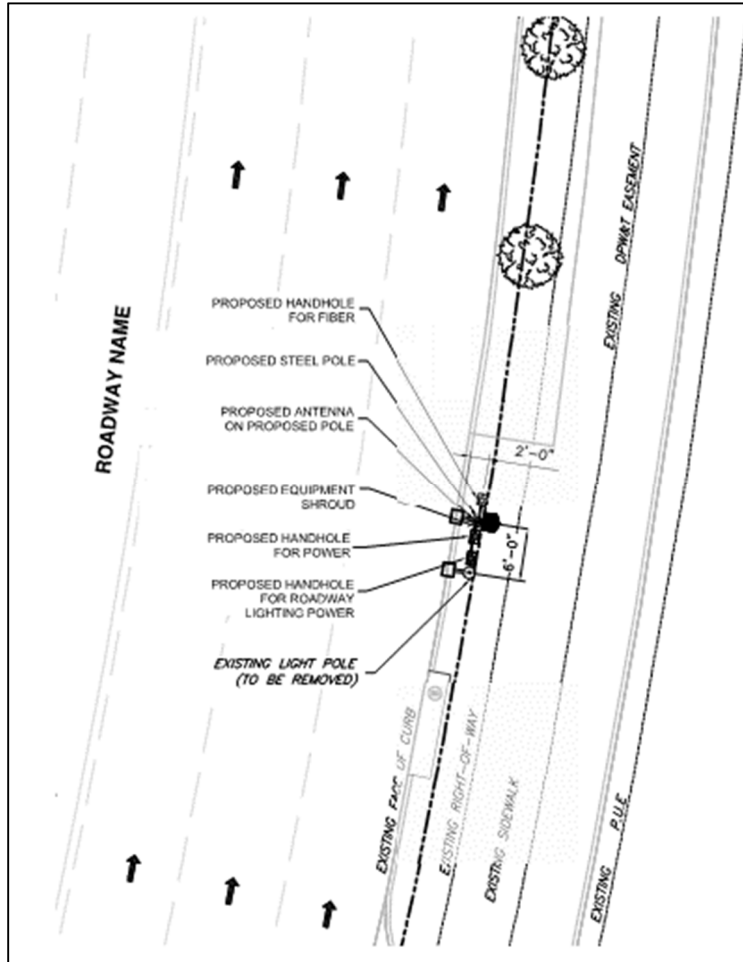

¹ Annotations shown are not all-inclusive of the various features and corresponding lines styles required on plans.



Figure 7
SAMPLE POLE PROFILE VIEW
SUITABLE LINE WEIGHTS AND ANNOTATIONS

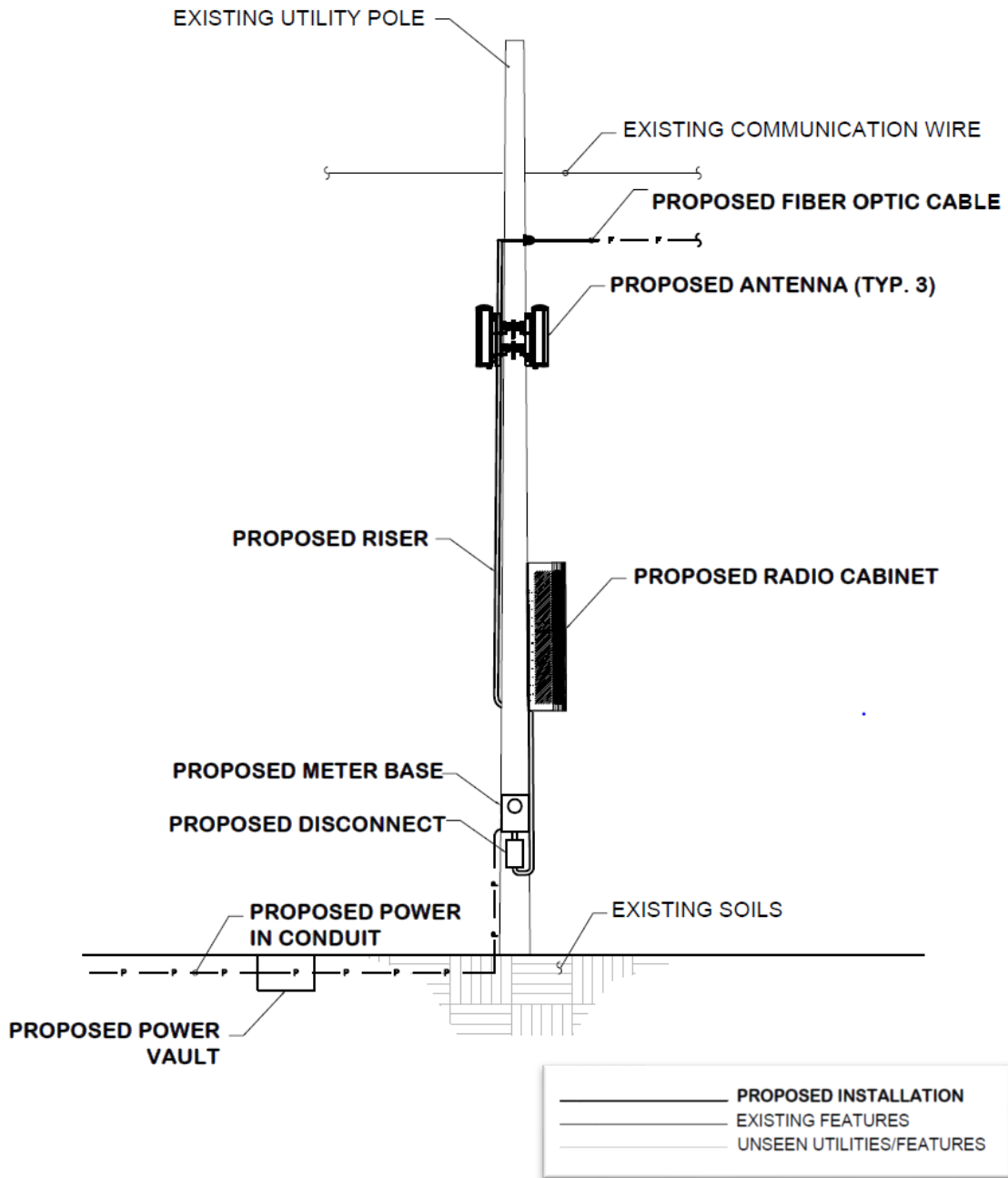



11.3.5 Required Sheets and Information

Design documentation shall include, at a minimum, the following sheets for all types of Applications except for Small Wireless Facility removals:

- a. Title;
- b. Plan (show existing structures, utilities, sidewalks, driveways, curbs, drive lanes, fences, and pertinent surface features in the vicinity of the installation);
- c. Profile;
- d. Equipment;
- e. Traffic Control Plan;
- f. Lighting Plans;
- g. Typical Detail(s);
- h. Lighting Analysis;
- i. Document of Demarcation.

Applications to remove a Small Wireless Facility shall include a Title Sheet, a list of items to be removed, traffic control plans, and a description of proposed restoration.

11.3.6 Title Sheet Requirements

The Title Sheet shall include the following items:

- a. Road Name and Road Code/Numerical Designation;
- b. Applicant name;
- c. Contractor name(s), if available;
- d. Pole owner name(s);
- e. Equipment owner;
- f. Applicant's site name and/or Site Identification Number;



- g. Complete address of the proposed Small Wireless Facility site. If none is available, use the closest address on record to assist reviewer(s) in locating the site;
- h. Latitude and Longitude of the Small Wireless Facility site, expressed in degree/decimal format (e.g. XX.XXXXXX) to NAD83 standard and accurate to ± 1.0 meter;
- i. Email and phone number for the Applicant's engineer;
- j. Email and phone number for the Applicant's single point of contact;
- k. 5-Square-Mile Area Map (see sample map in *Figure 8*);
- l. A list of applicable codes and engineering standards (most recent version) with which the Application complies;
- m. Sheet Index/Table of Contents listing only the sheets submitted in the plan set;
- n. Seal and signature from a State of Maryland-registered Professional Engineer (P.E.), placed in the lower right-hand corner of the Title Sheet;
- o. State of Maryland-registered Professional Certification statement with License Number and Expiration Date, placed next to the P.E. Seal and signature, per the Maryland Department of Labor and Licensing (DLLR) Board for Professional Engineers (see below):

***I, _____, HEREBY CERTIFY THAT
THESE DOCUMENTS WERE PREPARED OR APPROVED BY
ME, AND THAT I AM A DULY LICENSED PROFESSIONAL
ENGINEER UNDER THE LAWS OF THE STATE OF MARYLAND.
LICENSE NO.: _____
EXPIRATION DATE: _____***

Title Block, certification, seal, and signature shall appear close to each other.

- p. Signature line for the DPIE reviewing engineer(s) in the lower right-hand corner of the Title Sheet:

Prince George's County Engineer Signature

Prince George's County Consultant Engineer Signature



Figure 8
SAMPLE BASE MAP
(USE FOR 5-SQUARE-MILE AREA MAP)²

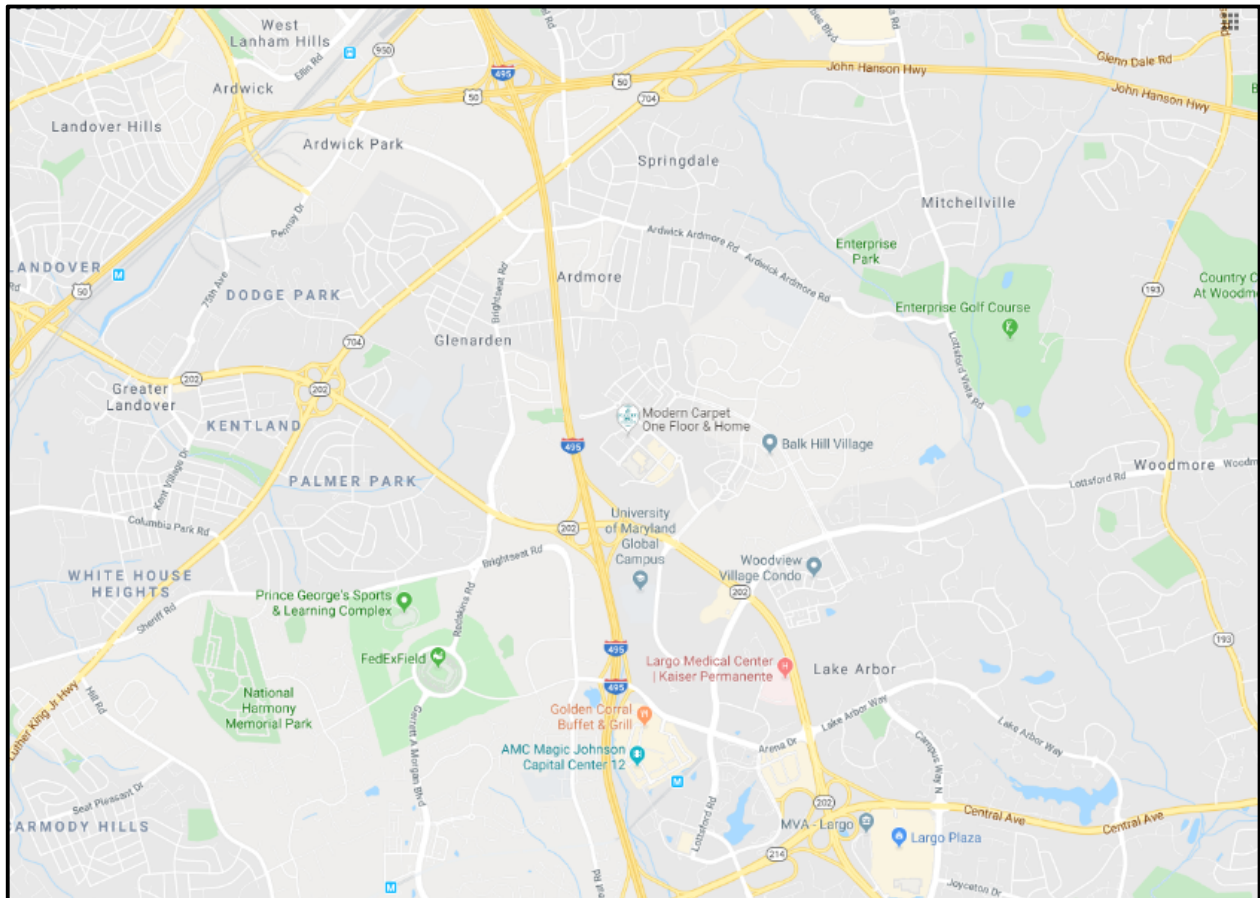

² Image Courtesy of Google Maps ©, 2019



11.3.7 Plan Sheet Requirements

The Plan sheets shall accurately depict existing features that apply, such as:

- a. State Roads and Interstates (roadway name and numerical designation);
- b. County and municipal roads (roadway name and numerical designation);
- c. Toll Roads (name);
- d. Private roads;
- e. Travel lanes with direction-of-traffic arrows;
- f. Clear Zones;
- g. County right-of-way and other rights-of-way and property lines;
- h. Sidewalks, pedestrian accessibility ramps, curbs, shoulders and drive lanes;
- i. Bike trails, bike lanes, and bike paths;
- j. All existing visible features, street furniture, and structures within the County right-of-way;
- k. Property addresses for parcels abutting the County right-of-way;
- l. Area zoning boundaries and indication of the zone-type, if any, e.g. residential, mixed-use, commercial, industrial;
- m. Premises/Parcel boundaries with address numbers, if applicable;
- n. Existing and proposed underground and above ground utilities;
- o. Utility appurtenances, e.g. valves, fire hydrants, handholes, manholes;
- p. Annotation to identify surface type, e.g. pavement, grass, bituminous, gravel;
- q. Stormwater Management Facilities and culverts;
- r. North Arrow indication;
- s. Recorded easements;
- t. Limits/boundary of construction and construction limits of disturbance;



- u. Notes to identify method of construction (if not explained on a typical sheet);
- v. Reference to any applicable detail illustrations on the plan sheet or a separate typical sheet;
- w. Any structure proposed to be installed or replaced;
- x. A color photo of the proposed Small Wireless Facility location (with approximate placement identified) taken during a field survey performed within sixty (60) days of the date of the Application submittal; internet street-view photos are not acceptable, and the size of the photo shall be no less than 3 in. X 4 in. when printed on an 11 in. X 17 in. sheet.

Plan sheets may have aerial imagery as the base layer. The Applicant's P.E. shall confirm that the aerial imagery is suitable to depict current conditions as related to the Application. If a plan sheet with aerial imagery is used, an additional plan sheet of the same perspective, orientation, scale, and detail will be required without the imagery. Regardless of the presentation method and basis of the construction documents, the Wireless Facility Owner and/or Applicant is always required to adhere to Subtitle 5A and 23 of the Prince George's County Code; the *Policy and Specification for Utility Installation and Maintenance*, including Appendix E.1, *Policy and Standards for Small Wireless Facility Installation and Maintenance*; and the *Department of Public Works and Transportation Specifications and Standards for Roadways and Bridges (2012)* to comply with all undergrounding requirements and with minimum acceptable clearances between Small Wireless Facility infrastructure and other existing nearby Facilities.

Plan sheets shall include the dimensions of all setbacks, offsets, and road widths related to the proposed Small Wireless Facility. Dimensioning should include but not be limited to:

- y. Road and County right-of-way widths;
- z. Distance from existing and proposed underground Facilities to the County right-of-way and edge of pavement;
- aa. Distance from flood plains to proposed Facilities;
- bb. Clear Zone width and offset to proposed Facilities;



- cc. Widths of sidewalks, pedestrian accessibility ramps, bike trails, bike lanes, and bike paths;
- dd. Setback to premises.

Plan Sheet features shall be drawn to scale except for symbols. Symbols are only to be used to preserve clarity, i.e. an existing 8 in. water line does not need to be drawn to scale. The main plan sheet scale must be within the range of 1:30 (1 in. = 30 ft.) and 1:50 (1 in. = 50 ft.). Detailed illustrations can be added to show greater clarity using a larger scale, e.g. 1:10 or 1:5).

11.3.8 Profile Sheet Requirements

A profile sheet shall accurately depict the following items:

- a. View direction (facing);
- b. The entire dimension of the Pole (new/proposed and existing);
- c. Existing structure view, if the proposed Small Wireless Facility will replace an existing structure;
- d. Proposed structure view, or two (2) different adjoining views, e.g. north and west, if it is a new structure;
- e. All attached Small Wireless Facility equipment, e.g. Antenna, ancillary equipment;
- f. Foundation view or reference to typical sheet for proposed foundations;
- g. Foundation buried/embedment depth for new or replacement Pole;
- h. Proposed hand boxes, vaults, and handholes;
- i. Proposed underground conduits within 10 ft. of the network Support Structure;
- j. Grounding detail or reference to a typical detail sheet;
- k. Proposed ground-based enclosure;



- l. Roadway features, including driveways, ramps, and sidewalks, to verify that the proposed Pole location will not interfere with proposed other improvements;
- m. Minimum depth of cover for proposed power and communications conduit;
- n. Offset from County right-of-way line to power source.

All the following items shall be dimensioned:

- o. Antenna height above Pole;
- p. Pole dimension at the base;
- q. Distance of Pole from the County right-of-way line, measured from the centerline of the support structure;
- r. Antenna and cabinet offset from Pole;
- s. Overall height of the Pole above grade;
- t. Vertical clearance of any adjacent features overhanging the roadway;
- u. Ground-based enclosures and height above grade;
- v. Pole-mounted enclosures and height above grade.

11.3.9 Equipment Sheet Requirements

Equipment Sheet set contain specialized typical details that tabulate the proposed equipment/enclosure volume for a Small Wireless Facility. An Equipment Sheet shall accurately include each of the following, as applicable:

- a. Plan view and profile view; multiple profile views; or combined plan and profile views, e.g. isometric view, of any visible component having a dimension greater than 6 in.;
- b. List of external components separately in typical detail;
- c. Length, width, and depth/height in “feet” and “inches” for any dimension that is greater than 10 ft.;
- d. Manufacturer and model number;



- e. Total volume in “cubic feet”.

Each component shall be identified as an Antenna, a Small Wireless Facility, or ancillary equipment. Each typical detail identified on an Equipment Sheet shall be numbered and labeled to provide a reference for the corresponding typical detail within the Small Wireless Facility plan set. The use of borders around details is required.

In addition to the individual component typical detail, each Equipment Sheet shall include a separate notation box that identifies the total Small Wireless Facility volume, in “cubic feet”, as shown in *Figure 9*. The “Total Cubic Feet Note” shall be in bold type, located in the lower right-hand corner of the Equipment Sheet.

Figure 9
SAMPLE “TOTAL CUBIC FEET” NOTE

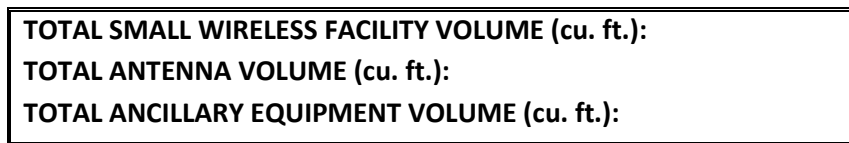

Linework and annotations shall be drafted using CAD software. Scanned or cropped images are not acceptable. Equipment shall be drawn to the scale on the plan view and profile view sheets.

11.3.10 Traffic Control Plan (TCP) Sheet Requirements

The Applicant shall provide the County with a set of traffic control plans (TCP) that fully-detail the operations and control of vehicular and pedestrian traffic on adjacent or impacted roadways and pedestrian Facilities during construction of, or maintenance related to Small Wireless Facilities. The TCP shall conform with safety and design standards set out in the current version of the *Maryland Manual on Uniform Traffic Control Devices (MdMUTCD)* and shall not be amended without the County’s written consent.

For all proposed work on any part of Pole infrastructure and/or equipment located within the Public Right-of-Way or easements, the TCP will detail how construction impacts will be mitigated for all modes of transportation, including but not limited to vehicular, pedestrian, and bike traffic, as well as transit. The County-approved



TCP shall be utilized during installation, maintenance and removal of any equipment relating to the deployment of Small Wireless Facilities.

11.3.11 Lighting Plan Sheet Requirements

The Applicant shall provide the County with a set of lighting plans (TCP) that fully-detail how temporary street lighting will be provided during construction, and at what levels to provide required lighting for motorists and pedestrians. The lighting plans must also show the ultimate lighting design for after the Small Wireless Facility is installed and operational. Lighting plans will be prepared based County Department of Public Works and Transportation Specifications and Standards for Roadways and Bridges (2012) and will show base information of roadway geometrics, existing adjacent lighting standards, drainage element, overhead and underground utilities, trees and vegetation, existing power service (location and size), and existing manholes, junction boxes and cables. Based on lighting analysis (see 11.3.13), the Applicant shall prepare a lighting design that details lighting levels and specifies pole type and size, luminaire type, connector kits and power source.

11.3.12 Typical Detail Sheet Requirements

A sheet of typical details can be part of the design documentation. Only one (1) typical sheet shall be included per design documentation, and each typical sheet shall contain no more than eight (8) individual details or illustrations to depict the scope of work related to the plan and profile sheets. Each typical detail shall be numbered and labeled to reference the typical sheet and specific individual details. The use of borders around typical details is required (see *Figure 10*).



Figure 10
COUNTY DPW&T TYPICAL DETAIL (SAMPLE)

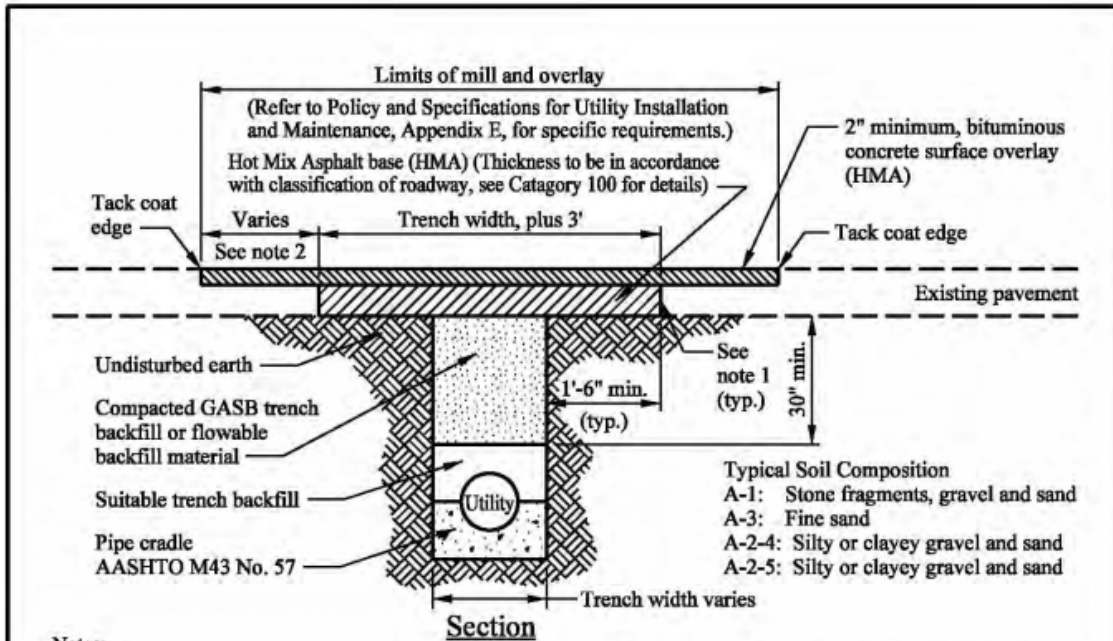

Notes:

1. Existing pavement shall be milled or saw cut full depth where the limits of mill and overlay meet the existing pavement.
2. For longitudinal and transverse cuts, the limits of the mill and overlay shall be in accordance with the Policy and Specification for Utility Installation and Maintenance, Attachment 2 and 3, for specific requirements.
3. When the distance from the edge of the existing pavement to the edge of new asphalt base is 3 feet or less, the existing pavement shall be removed and replaced to the edge.
4. For transverse cuts, perimeter milling with a minimum width of 12" shall be required.
5. All milling shall be 2" minimum depth.
6. Hot Mix Asphalt (HMA) base and surface overlay mix design to be in accordance with classification of roadway, (see Category 100 for details)
7. Hot Mix Asphalt (HMA) surface shall be placed to a depth equal to the depth of the existing surface or 2" minimum, whichever is greater. Hot Mix Asphalt (HMA) base shall be a depth equal to the depth of the existing base or 4", whichever is greater. All Hot Mix Asphalt (HMA) shall be compacted to an in-place density of 92 to 97 percent of the maximum specific gravity.
8. The top two-and-one-half (2 1/2) feet of all trench backfill beneath the pavement layer shall be compacted Graded Aggregate Subbase (GASB) to 95% of the maximum dry density per AASHTO Designation T-99. Prior to and during compaction, moisture of fill material shall be maintained within 2% of optimum. The fill shall be placed and compacted in horizontal layers not to exceed 8" in thickness (loose). GASB shall conform to the requirements of the latest edition MSHA Standard Specifications for Construction and Materials manual. Flowable fill material may also be used when approved by the Department.
9. Suitable trench backfill below the top two-and-one-half (2 1/2) feet down to five (5) feet deep shall be placed in horizontal layers not to exceed 8 inches (loose) and compacted to at least 92% of maximum dry density per AASHTO Designation T-99. Moisture content shall be maintained within 2% optimum.
10. Trench backfill below five (5) feet deep shall be placed and compacted in layers not to exceed 1 foot in thickness (loose).
11. All compaction work shall be performed using suitable equipment such as sheepfoot rollers or pneumatic and/or vibratory plate type compaction equipment. Backfill material shall be placed evenly around the structure and shall be free of boulders, frozen lumps or foreign matter that could cause hard spots or decompose creating voids.
12. Where cave-ins under existing asphalt pavement occur, the existing pavement shall be saw-cut 18 inches beyond the limit of the cave-in.
13. Use an independent testing lab to verify compaction.

APPROVED:			DEPARTMENT OF PUBLIC WORKS AND TRANSPORTATION	
DIRECTOR _____ DATE _____			Prince George's County, MD	
REVISION	DATE		APPROVED BY	STD. 300.18



11.3.13 Lighting Analysis

A lighting level photometric analysis must be submitted with all new and replacement Pole Applications. Lighting level analysis utilizing the “Point-by-Point” method need to be conducted for existing conditions and for conditions after the installation of all equipment relating to the deployment of Small Wireless Facilities. Lighting level analysis and a document sealed by a Maryland-registered Professional Engineer must be provided, certifying that the proposed wireless attachment will not adversely impact existing lighting levels, and will, at a minimum, maintain uniformity in the lighting levels along the corridor or within the vicinity of the proposed installation.

Figure 11
LIGHTING PHOTOMETRICS OUTPUT (SAMPLE)

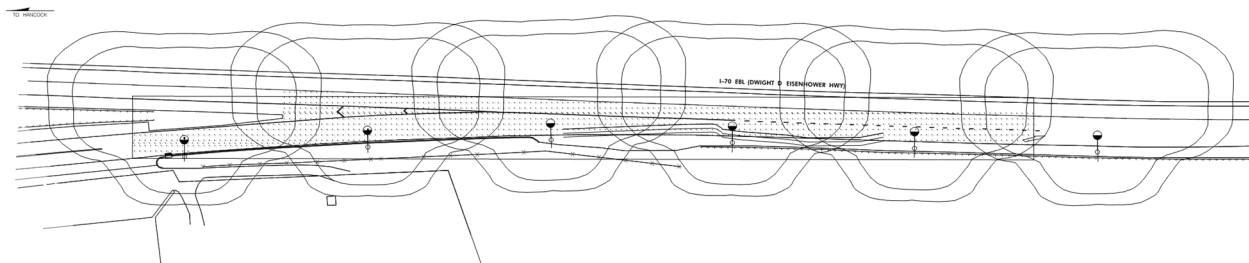

LIGHTING CALCULATION ZONE	ROADWAY CLASSIFICATION	MAXIMUM ILLUMINANCE LEVEL (fc)	MINIMUM ILLUMINANCE LEVEL (fc)	AVERAGE ILLUMINANCE (Footcandle) RECOMMENDED	AVERAGE ILLUMINANCE (fc) ACTUAL	UNIFORMITY RATIO (Low/High) RECOMMENDED	UNIFORMITY RATIO (Low/High) ACTUAL	VEILING LUMINANCE RATIO (Low/High) RECOMMENDED	VEILING LUMINANCE RATIO (Low/High) ACTUAL
EB MD 144 RAMP TO I-70	FREEWAY CLASS B	2.1	.4	.6	1.01	3	2.53	.3	.26

11.3.14 Document of Demarcation

The County understands that different Applicants, and different Applications by an Applicant, may take unique approaches to providing backhaul to the Facility. In some cases, the Applicant may propose to build and own the backhaul; whereas in other instances, the Applicant might build and own the Small Wireless Facility and have another entity build and own the backhaul. An additional approach could involve the Applicant obtaining backhaul from the County. All Applications shall clearly indicate the demarcation between the backhaul and the Small Wireless Facility.



If Small Wireless Facility equipment will be located on the Pole or on the ground in close proximity to the Pole, the vault or pedestal containing the Small Wireless Facility equipment is the demarcation point. The following two (2) Figures illustrate physical demarcations between the backhaul and the Small Wireless Facility at a line interface unit (LIU) also known as the network interface device (NID). *Figure* illustrates a scenario in which the backhaul (dotted line) is delivered aerially. The LIU/NID shown is located on the Pole; however, if the cabinet is on the ground, it could also be in a nearby handhole or within the cabinet. The backhaul provider provides transport from a splice point and drops the line to the NID.

Figure 12
COMMUNICATIONS DEMARCATION POINT
(AERIAL EQUIPMENT)

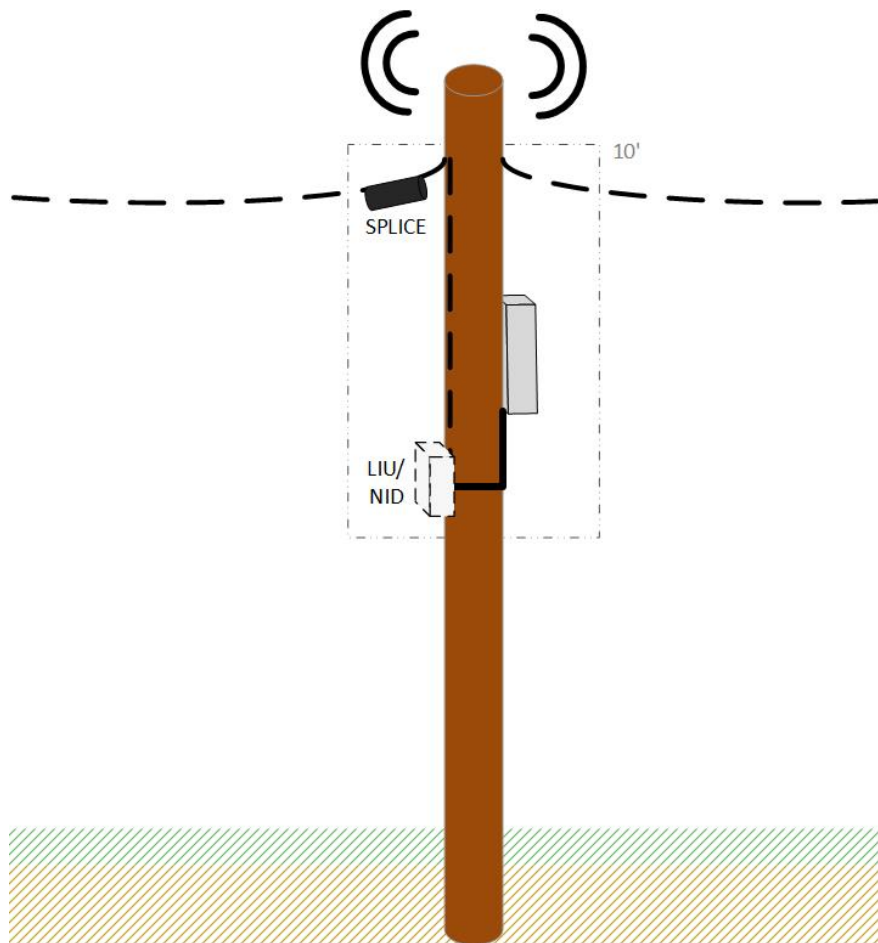
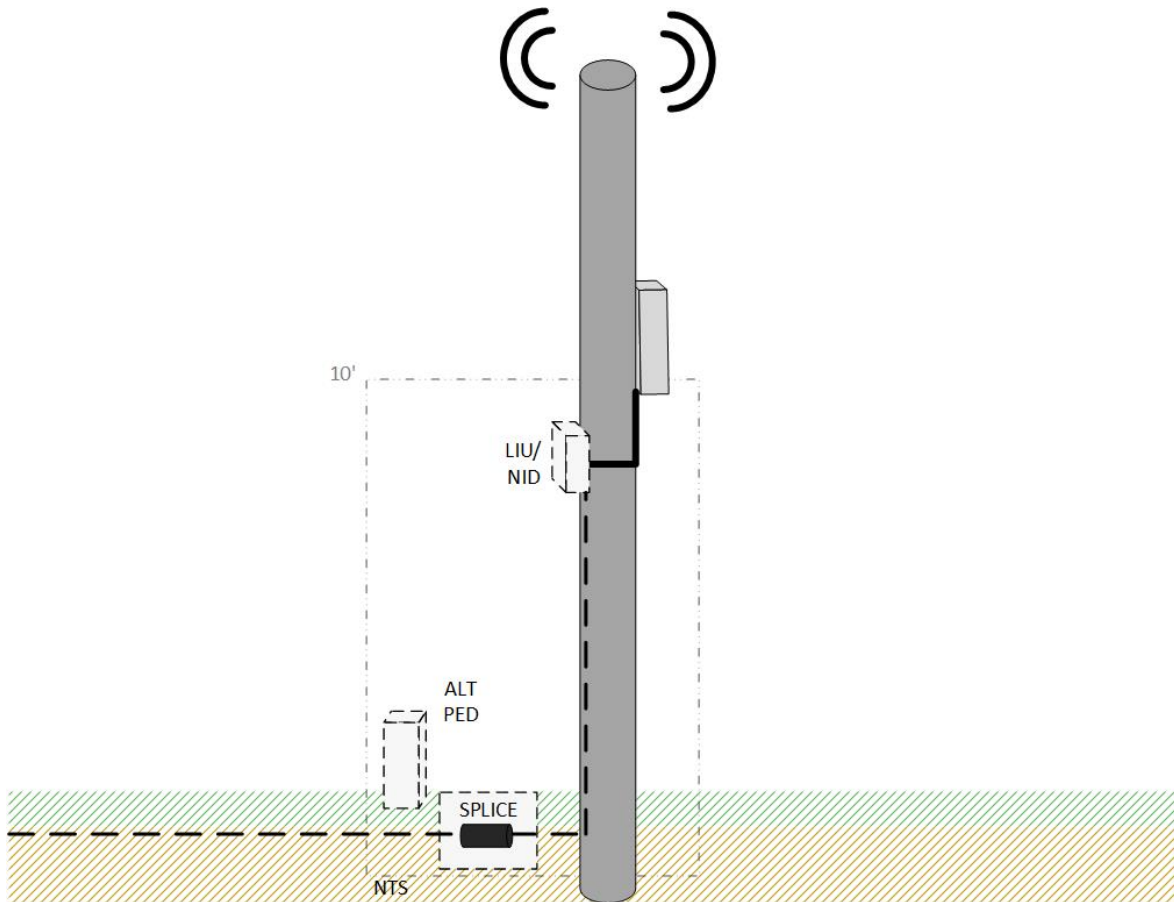

Figure illustrates another scenario in which the backhaul (dashed line) is delivered underground. The backhaul provider typically installs a handhole containing the transport cable for the Small Wireless Facility connection. It is recommended that the handhole is located within 10 ft. of the Pole. The demarcation point is where the backhaul connects to the LIU/NID.

Figure 13
COMMUNICATIONS DEMARCATION POINT
(UNDERGROUND EQUIPMENT)





SECTION 12 TERMS AND PROVISIONS

Additional terms and provisions related to the deployment of Small Wireless Facilities in public rights-of-way, such as insurance, fees, Permit processes, maintenance, inspections, and abandonment may be found in the *Department of Public Works Specifications and Standards for Roadways and Bridges (2012)* and the uniform Master License Agreement promulgated by the County Executive in accordance with Section 5A-159 of the Prince George's County Code.

APPENDIX A STANDARD / PRE-APPROVED DESIGNS

Small Wireless Facilities shall follow one of the following standard designs, which establish minimum standards, expedite the review process, establish consistency in the types of Poles, and provide the Applicant with the flexibility of a wide range of configurations and potential equipment suppliers.

- **Design 1** – Smooth, Cylindrical Streetlight Pole
- **Design 2** – Streetlight Pole with Equipment in Pole Base
- **Design 3** – Streetlight Pole with Equipment in Pole-Mounted Cabinet
- **Design 4** – Decorative Streetlight Pole

In addition to following the standard designs, the Small Wireless Facility should adhere to the conduit standards as shown in the Conduit Typical.

Typical designs and specifications are provided below.



Figure 14
DESIGN 1 – SMOOTH, CYLINDRICAL STREETLIGHT POLE

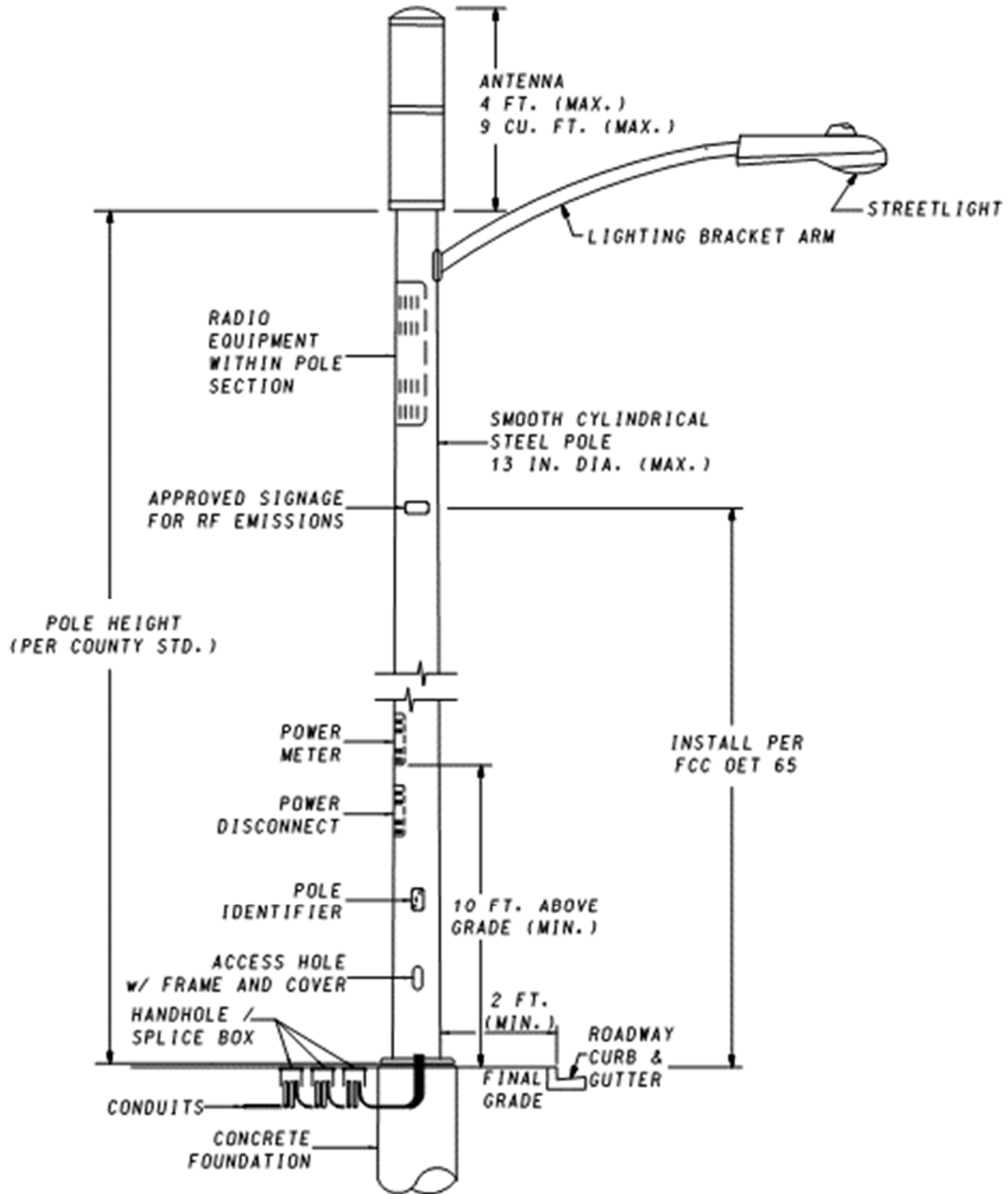



Figure 15
DESIGN 2 – STREETLIGHT POLE WITH EQUIPMENT
IN POLE BASE

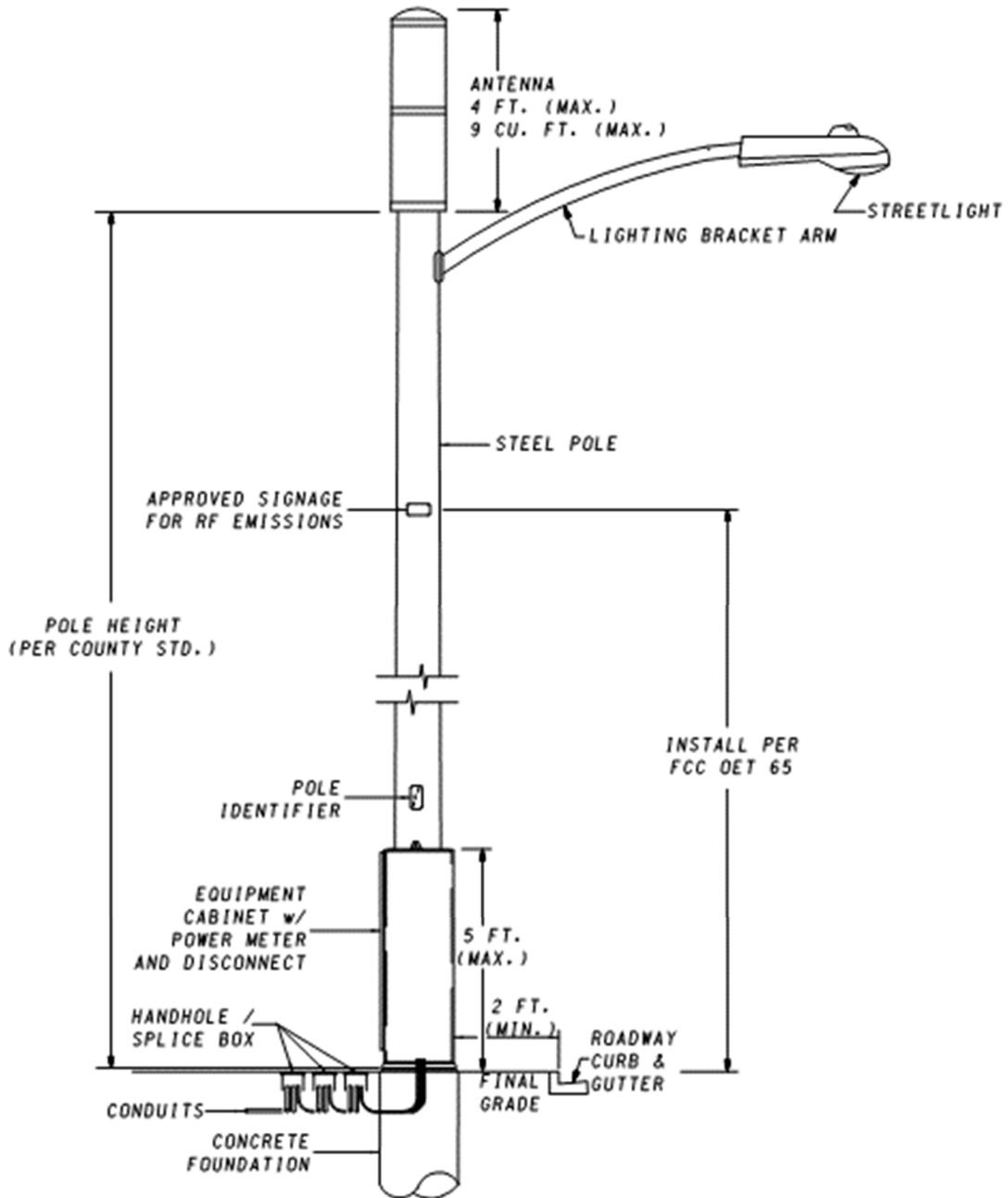



Figure 17
DESIGN 4 – DECORATIVE STREETLIGHT POLE

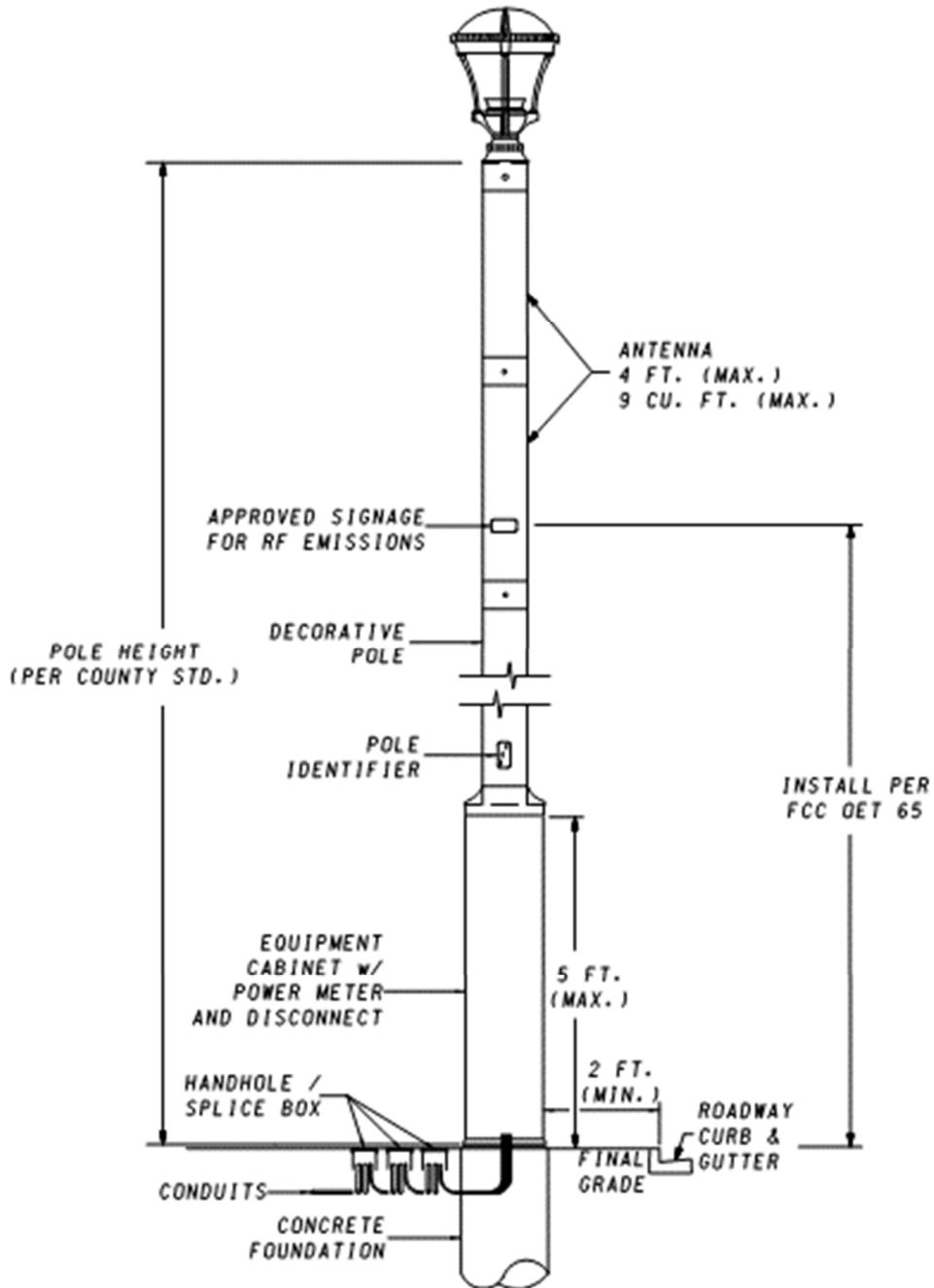



Figure 18
CONDUIT TYPICAL

